

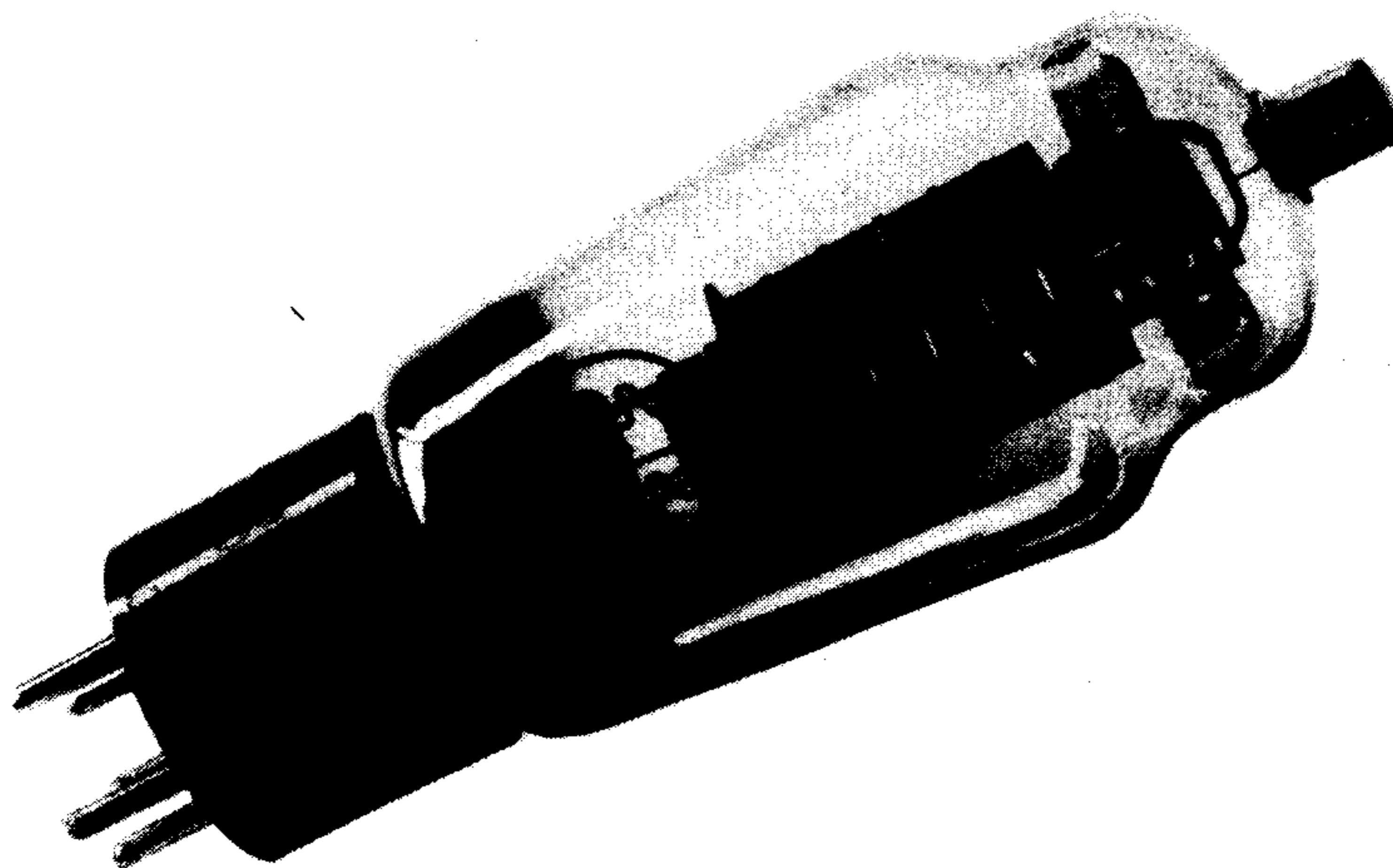

807



BEAM TETRODE

APPLICATION REPORT

This valve was previously coded 5B/250A

The valve type 807 is an indirectly heated beam tetrode designed for use in the output stages of Public Address equipment, or as an RF amplifier or frequency multiplier in transmitters. The heater is intended for operation in parallel with other valves in AC operated equipment.

This report contains characteristics of the valve and details of its use in AF and RF equipment.

NOTE: The maximum ratings given in this report are absolute maxima and should not be exceeded in any circumstances.





DESCRIPTION: The valve consists of a beam tetrode unit capable of an output of the order of 15 watts. The unit is mounted in a standard ST16 bulb, having the plate connection brought out to a top cap and is based with a 5 pin low loss base.

CHARACTERISTICS:

Cathode:	Indirectly heated	
	Voltage	6.3 volts*
	Current (Nominal)	0.9 ampere
	Max. DC Heater to Cathode potential	250 volts
	Max. Cathode Current	125 mA

* The voltage should not vary more than 5% from the rated value if the valve is used under Class AB2 conditions or where the operating conditions are close to the maximum ratings, nor more than 7% if used under Class A or AB1 conditions.

Dimensions:	Max. Overall Length	5 $\frac{3}{4}$ ins.
	Max. Diameter	2 $\frac{1}{8}$ ins.
	Max. Seated Height	5 $\frac{1}{8}$ ins.

Base: Medium shell small 5 pin low loss

Basing Connections:	Pin 1 Heater
	Pin 2 Screen g ₂
	Pin 3 Control Grid g ₁
	Pin 4 Cathode and Beam Confining Plates
	Pin 5 Heater
	Top Cap Plate

Ratings:

TETRODE CONNECTION:

Max. Plate Voltage	600 volts*
Max. Screen Voltage	300 volts*
Max. Plate Dissipation	25 watts*
Max. Screen Dissipation	3.5 watts*
Max. DC Grid Current	5 mA*

TRIODE CONNECTION (Plate and Screen Strapped):†

Max. Plate Voltage	400 volts*
Max. Plate Dissipation	25 watts*
Max. Signal DC Plate Current	125 mA*

† In order to avoid parasitic oscillation the plate and pin 2 should be connected together through a 100 ohm resistance or an RF choke of about 20 microhenries.

* These ratings are absolute and must be reduced under certain specified conditions referred to later in this report.

Frequency Ratings: The ratings given in the above paragraphs apply to frequencies up to 60 Mc/s. Above this frequency the maximum plate voltage and plate dissipation must be reduced in the correct proportion. Thus at 80 Mc/s they are reduced to 80%, and at 120 Mc/s to 50% of the values specified. The valve is not normally satisfactory for operation at frequencies higher than 120 Mc/s.

Inter-electrode Capacitances (approx.):

C _{p,g}	0.2 pF*
C _{in}	12.5 pF
C _{out}	8.2 pF
C _{h,k}	10.0 pF

* Measured with external shield.





Mounting: The valve should be mounted in equipment so that it operates in a vertical position with the base downward. In exceptional circumstances it is permissible to mount the valve horizontally but only in such a way that the plane of the major axis of the control grid and screen are vertical. The plane of these grids is correct if Pin 3 is on the vertical diameter of the valve base.

Ventilation: As this valve runs appreciably hot in operation the layout and design of equipment should be such that adequate ventilation is afforded to ensure a safe bulb temperature under all conditions.

Characteristic Curves: Curves are attached to this report as follows:

I_p/E_p with $E_{g2} = 250$ volts and various values of E_{g1}	No. 307-210
I_p/E_p " " = 300 " " " " " " "	No. 307-211
I_p/E_p for various values of E_{g1} with valve connected as a triode	No. 307-212
I_{g2}/E_p with $E_{g2} = 250$ volts and various values of E_{g1}	No. 307-213
I_{g2}/E_p " " = 300 " " " " " " "	No. 307-214
I_{g1}/E_p " " = 250 " " " " " " "	No. 307-215
I_{g1}/E_p " " = 300 " " " " " " "	No. 307-216

TYPICAL OPERATION AT AUDIO FREQUENCIES:

General Recommendations: Due to the relatively high slope of this valve, trouble may be experienced with parasitic oscillation, and it is advised that a resistor of 100 ohms is wired in series with the plate, directly connected to the valve top cap contact. This resistance should be reduced to 47 ohms in the case of Class AB2 operation. A series grid resistor may also be employed, if necessary, wired directly to the valve holder grid contact, but the value must be chosen after due consideration of the effect on the frequency response. Such a resistance should never exceed 100,000 ohms for Class A operation, and should not be employed for Class AB2 operation.

The type of input coupling should be designed to avoid the introduction of excessive resistance into the grid circuit. It is preferable that such resistance does not exceed 100,000 ohms, except in the case of Class A operation under automatic bias conditions where, if essential, the value may be as high as 500,000 ohms.

Class 'A' Amplifier (Single Ended):

TRIODE CONNECTION (Pin 2 and top cap strapped):

Heater Voltage	6.3	6.3	volts
Plate Voltage	250	250	volts
Grid Voltage	-20	—	volts
Autobias Resistor	—	500	ohms
Plate Current (no signal)	40	40	mA
Plate Impedance	1700	—	ohms
Amplification Factor	8	—	
Mutual Conductance	4.7	—	mA/V
Plate Load Impedance	5000	6000	ohms
Peak AF Grid Voltage	20	20	volts
Total Harmonic Distortion	4.5	4.0	%
Power Output	1.3	1.1	watts

Curves are attached to this report which show the relation between power output, harmonic distortion and input signal voltage for fixed bias (Curve 307-331) and for autobias (Curve 307-332).





Class 'A' Amplifier (Push-Pull):

TRIODE CONNECTION (Pin 2 and top cap strapped)

Plate Voltage	250	250	325	325	volts
Grid Voltage	-20	—	-30	—	volts
Autobias Resistor	—	250	—	375	ohms
Plate Current (no signal)	80	80	80	80	mA
Output Load Impedance (plate - plate)	5000	5000	8000	8000	ohms
Peak AF Grid Voltage	40	40	60	60	volts
Total Harmonic Distortion	0.35	0.4	0.7	0.6	%
Power Output	3.5	3.1	5.75	6.0	watts

NOTE—Values are given for two valves.

Curves are attached to this report which show the relation between power output, harmonic distortion and input signal voltage for autobias at 250 volts HT (Curve 307-333) and at 325 volts HT (Curve 307-336) and for fixed bias at 250 volts HT (Curve 307-334) and at 325 volts HT (Curve 307-335).

Class 'A' Amplifier (single ended):

TETRODE CONNECTION:

Plate Voltage	250	250	350	500	500	volts
Screen Voltage	250	250	250	200	200	volts*
Grid Voltage	-14	—	-18	-14.5	—	volts
Autobias Resistor	—	170	—	—	280	ohms
Plate Current	72	75	54	50	50	mA
Screen Current	5.0	5.4	2.5	1.6	1.6	mA
Plate Impedance	22,500	—	33,000	38,500	—	ohms
Mutual Conductance	6.0	—	5.2	5.7	—	mA/V
Plate Load Impedance	2500	2500	4200	6000	6000	ohms
Peak AF Grid Voltage	14	16	18	14.5	15.5	volts
Total Harmonic Distortion	10	10	15	11.6	13.6	%
Power Output	6.5	6.5	10.8	11.5	11.0	watts

* In cases where the screen voltage is lower than the plate voltage it should be obtained from a potentiometer between the HT line and chassis, adequately by-passed to AF signals and not by means of a series resistor.

Curves are attached to this report which show the relation between power output, distortion and input signal for the 250 volt fixed bias condition (Curve 307-337) and for automatic bias (Curve 307-338).





Class 'A' Amplifier (Push-Pull):

TETRODE CONNECTION:

Plate Voltage	250	270	270	500	500	600	600	volts
Screen Voltage	250	270	270	300	300	300	300	volts
Grid Voltage	-16	-17.5	—	-27	—	-29.5	—	volts
Autobias Resistor	—	—	125	—	270	—	360	ohms
Peak AF Grid-Grid Voltage	32	35	40	54	72	59	81	volts
Plate Current (no signal)	120	134	134	100	100	80	80	mA
Plate Current (max. signal)	140	155	145	154	119	150	97	mA
Screen Current (no signal)	10	11	11	2.5	2.5	1.5	1.5	mA
Screen Current (max. signal)	16	17	17	20	16.5	17.5	17.5	mA
Output Load Impedance (plate-plate)	5000	5000	5000	8000	9000	10,000	10,000	ohms
Total Harmonic Distortion	2	2	4	2.6	2.7	2.2	4.1	%
Power Output	14.5	17.5	18.5	38	32.5	47.5	36.5	watts

NOTE—Values are given for two valves.

Curves are attached to this report which show the relation between power output, distortion and input signal for various conditions. Curves 307-206, 307-208 for fixed bias and plate voltages of 500 and 600 volts respectively; Curves 307-207, 307-209 for autobias and plate voltages of 500 and 600 volts respectively.

Class 'ABI' Amplifier (Push-Pull):

TRIODE CONNECTION (Pin 2 and top cap strapped):

Plate Voltage	400 volts*
Grid Voltage	-45 volts
Plate Current (no signal)	60 mA
Plate Current (max. signal)	140 mA
Output Load Impedance (plate - plate)	3000 ohms
Peak AF Grid-Grid Voltage	90 volts
Total Harmonic Distortion	3%
Power Output	15 watts

NOTE—Values are given for two valves.

*This voltage is based upon the absolute maximum ratings and if the HT line voltage is subject to mains or component variations the value should be reduced to ensure that it is not exceeded at any time.

Curve 307-238, which is attached to this report, shows the relation between power output, distortion and input signal.



**Class 'AB1' Amplifier (Push-Pull):****TETRODE CONNECTION:**

Plate Voltage	360	360	volts
Screen Voltage	270	270	volts
Grid Voltage	-22.5	—	volts
Autobias Resistor	—	250	ohms
Plate Current (no signal)	88	88	mA
Plate Current (max. signal)	138	100	mA
Screen Current (no signal)	5	5	mA
Screen Current (max. signal)	16	19	mA
Output Load Impedance (plate - plate)	6600	9000	ohms
Peak AF Grid-Grid Voltage	45	57	volts
Total Harmonic Distortion	1.8	4	%
Power Output	26.5	24	watts

NOTE—Values are given for two valves.

Curves are attached to this report which show the relation between power output, distortion and input signal voltage for the above conditions. Curve 307.339 for fixed bias, and Curve 307.340 for autobias.

Class 'AB2' Amplifier (Push-Pull):**TETRODE CONNECTION:****Ratings:**

Max. Plate Voltage	600 volts
Max. Screen Voltage	300 volts
Max. Signal DC Plate Current	120 mA
Max. Signal Plate Input Power	60 watts
Max. Signal Screen Input Power	3.5 watts
Max. Plate Dissipation	25 watts

Typical Operating Conditions:

Plate Voltage	360	360	400	500	600	volts
Screen Voltage	225	270	300	300	300	volts
Grid Voltage	-18	-22.5	-25	-29	-30	volts
Plate Current (no signal)	78	88	90	72	60	mA
Plate Current (max. signal)	162	220	240	240	200	mA
Screen Current (no signal)	3.5	5	5	5	5	mA
Screen Current (max. signal)	21	35	23	22	21	mA
Output Load Impedance (plate - plate)	6000	3800	3200	4240	6400	ohms
Peak Grid-Grid Input Power	190	400	200	200	100	mW
Total Harmonic Distortion	8	10	4	4.5	3.5	%
Power Output	31	47	55	75	80	watts

NOTE—Values are given for two valves.





It is essential for Class 'AB2' operation that the regulation of the plate and screen supplies is such that the voltages remain constant within 5% and that of the grid bias within 3%, between no signal and maximum signal conditions. The driver stage should be capable of supplying the grids of the two valves with the specified peak voltages at low distortion. The effective resistance per grid circuit presented by the driver valve and/or transformer should not exceed 500 ohms, and the effective impedance represented by leakage inductance, or equivalent, at the highest desired response frequency, should not exceed 700 ohms.

Curves are attached to this report which show the relation between power output, distortion and input signal voltage for the above conditions. Curve 307-341 for 360 volts, Curve 307-217 for 400 volts, Curve 307-218 for 500 volts and Curve 307-219 for 600 volts.

The circuit of a typical amplifier giving 75 watts output from two type 807 valves in Class 'AB2' push-pull is given on 401-20. In this unit the output stage is driven by a 6SN7GT operating as a cathode follower which is fed from a 6SN7GT phase splitter stage. A pre-amplifier which is suitable for use with the output unit is also shown on 401-20. This pre-amplifier gives a choice of two inputs: Input 1 is used for microphones or LP lightweight pickups, whereas Input 2 is for a normal pickup. The cathode follower output stage of the pre-amplifier is matched to 10,000 ohms and permits the use of an appreciable length of cable between the two units. The power supply for the output unit is given on 401-12 and the transformer and choke details on 401-21. Details of the performance of each of the units is given on 401-22.

Class 'B' Amplifier (Push-Pull): In order to avoid the necessity of good regulation of the screen and grid bias supplies when used in Class 'AB2' a circuit of the type shown on 432-1 may be used. In this case the screen is connected directly to the secondary of the input transformer and to the control grid via a resistance. The drive required with this type of circuit is higher than that given above, but it may be obtained without difficulty in the manner shown.

TYPICAL OPERATION AT RADIO FREQUENCIES:

General Recommendations: Due to their relatively high slope these valves are prone to parasitic oscillation and it is advised that a small resistance of the order of 47 ohms, or less if essential, should be wired in series with the plate, directly connected to the top cap.

The total effective grid circuit resistance should not exceed 25,000 ohms and the DC grid circuit should not exceed 5 mA at any time. Attention is drawn to the paragraph regarding frequency ratings.

Neutralisation is not required normally when used as an RF amplifier but it is advantageous for the valve to be mounted through a hole in a screen or sunk in the chassis so that the edges of the screen or chassis are on the same plane as the shield just below the lower mica insulator. This method of mounting will reduce the plate-control grid capacity to a minimum. The valve should never be enclosed in a metal screening can, because it would result in over-heating.

When used as an oscillator the heater to cathode insulation should not be across any part of the oscillator tuned circuit as this will give rise to frequency drift and hum modulation. The valve may be used in an electron coupled oscillator circuit if the heater voltage is supplied via RF chokes, or via a winding interwound with the part of the coil associated with the cathode tap.





If cathode keying is employed a resistance not exceeding 0.25 megohm should be wired permanently between heater and cathode. Keying by opening the screen circuit alone should not be employed because the plate current may not be cut off completely by disconnection of the screen. Further, if the valve is operated near the maximum ratings there may be sufficient screen emission to maintain the screen voltage during the 'key up' periods and prevent the use of 'break in' facilities. If it is necessary to interrupt the plate current by disconnecting the screen supply, the lowest practicable resistance should be connected permanently between the screen and cathode.

RF Amplifier, Class 'B' Telephony:

Carrier conditions per valve for use at maximum modulation factor of 1.0.

Ratings:

Plate Voltage	600 volts max.
Screen Voltage	300 volts max.
Plate Input Power	37.5 watts max.
Screen Input Power	2.5 watts max.
Plate Dissipation	25 watts max.
DC Plate Current	80 mA

Typical Operating Conditions:

Plate Voltage	400	500	600	volts
Screen Voltage	250	250	250	volts
Grid Voltage	-25	-25	-25	volts
DC Plate Current	75	75	62.5	mA
DC Screen Current	4	4	4	mA
DC Grid Current	0	0	0	mA
Peak RF Grid Voltage	30	30	20	volts*
Driving Power (approx.)	0.25	0.25	0.2	watts†
Power Output (approx.)	9	12.5	12.5	watts

* Total effective grid circuit resistance should not exceed 25,000 ohms.

† At crest of AF cycle with modulation factor of 1.0.

RF Amplifier, Class 'C' Plate Modulated:

Carrier conditions per valve for use at maximum modulation factor of 1.0.

Ratings:

Plate Voltage	475 volts max.
Screen Voltage	300 volts max.
Grid Voltage	-200 volts max.
Plate Input Power	40 watts max.
Screen Input Power	2.5 watts max.
Plate Dissipation	16.5 watts max.
DC Plate Current	83 mA max.
DC Grid Current	5 mA max.





Typical Operating Conditions:

Plate Voltage	325	400	475	volts
Screen Voltage	225	225	225	volts*
Screen Series Resistor	20,000	30,000	50,000	ohms*
Grid Voltage	-75	-80	-85	volts†
Grid Resistor	25,000	22,800	21,300	ohms†
DC Plate Current	80	80	83	mA
DC Screen Current	5	5.75	5	mA
DC Grid Current (approx.)	3	3.5	4	mA
Peak RF Grid Voltage	90	95	110	volts
Driving Power (approx.)	0.25	0.3	0.4	watts
Power Output (approx.)	17.5	22.5	27.5	watts

* Preferably obtained from a modulated fixed supply or from the modulated plate supply via the resistance value shown.

† The total effective grid circuit resistance should not exceed 25,000 ohms, the voltage may be obtained from the resistor shown, or by a combination of cathode resistor and grid leak bias or preferably fixed supply and grid leak bias.

5.4 RF Amplifier and Oscillator, Class 'C' Telegraphy:

Key down conditions per valve without modulation:*

Ratings:

Plate Voltage	600 volts max.
Screen Voltage	300 volts max.
Grid Voltage	-200 volts max.
Plate Input Power	60 watts max.
Screen Input Power	3.5 watts max.
Plate Dissipation	25 watts max.
DC Plate Current	100 mA max.
DC Grid Current	5 mA max.

Typical Operating Conditions:

Plate Voltage	400	500	600	volts
Screen Voltage	250	250	250	volts
Screen Series Resistor	20,000	42,000	50,000	ohms
Grid Voltage	-45	-45	-45	volts†
Grid Resistor	12,800	12,800	12,800	ohms†
Cathode Resistor	410	410	410	ohms†
DC Plate Current	100	100	100	mA
DC Screen Current	7.5	6.0	7.0	mA
DC Grid Current (approx.)	3.5	3.5	3.5	mA
Peak RF Grid Voltage	6.5	6.5	6.5	volts
Driving Power (approx.)	0.2	0.2	0.2	watts
Power Output (approx.)	25	30	40	watts

* Modulation essentially negative may be used if the positive peak of the AF envelope does not exceed 115% of the carrier amplitude.

† The total effective grid circuit resistance should not exceed 25,000 ohms; the voltage may be obtained from a fixed supply or by the grid resistor shown, or a cathode resistor of 410 ohms or by combination methods. If the preceding stage is keyed some fixed bias is essential.





RF Frequency Multiplier, Telegraphy:

RF Doubler:

Continuous ratings as a doubler without modulation:

Plate Voltage	400	500	600	volts
Screen Voltage	250	250	250	volts
Screen Series Resistor	18,700	38,500	46,500	ohms
Grid Voltage	-84	-84	-84	volts
Grid Resistor	12,500	15,500	18,000	ohms
Cathode Resistor	350	350	350	ohms
DC Plate Current	90	80	75	mA
DC Screen Current	8.0	6.5	7.5	mA
DC Grid Current (approx.)	4.0	3.5	3.0	mA
Peak RF Grid Voltage	105	105	105	volts
Driving Power (approx.)	0.4	0.35	0.3	watts
Power Output	14	16	20	watts*

* Measured with typical tank coil doubling from 7 to 14 Mc/s.

RF Trebler:

Continuous ratings as a trebler without modulation:

Plate Voltage	400	500	600	volts
Screen Voltage	250	250	250	volts
Screen Series Resistor	25,000	62,500	115,000	ohms
Grid Voltage	-95	-95	-100	volts
Grid Resistor	16,250	20,000	25,000	ohms
Cathode Resistor	400	400	450	ohms
DC Plate Current	70	60	53	mA
DC Screen Current	6	4	3	mA
DC Grid Current (approx.)	4	3.5	3	mA
Peak RF Grid Voltage	115	115	120	volts
Driving Power (approx.)	0.45	0.4	0.35	watts
Power Output	5	6	7	watts*

* Measured with typical tank coil trebling from 7 to 21 Mc/s.

Operation as Series Valve in Voltage Stabilisers: Due to the fairly high DC cathode current obtainable with this valve it is suitable for use as the series valve in a voltage stabiliser. The valve should be strapped as a triode, observing those precautions mentioned in "ratings" on page 2. Care should be taken to ensure that the maximum ratings are not exceeded under the worst possible operating conditions of the stabiliser unit, i.e., maximum supply voltage, maximum current drain and minimum DC output voltage.

AN I.T.E.T.
ASSOCIATE

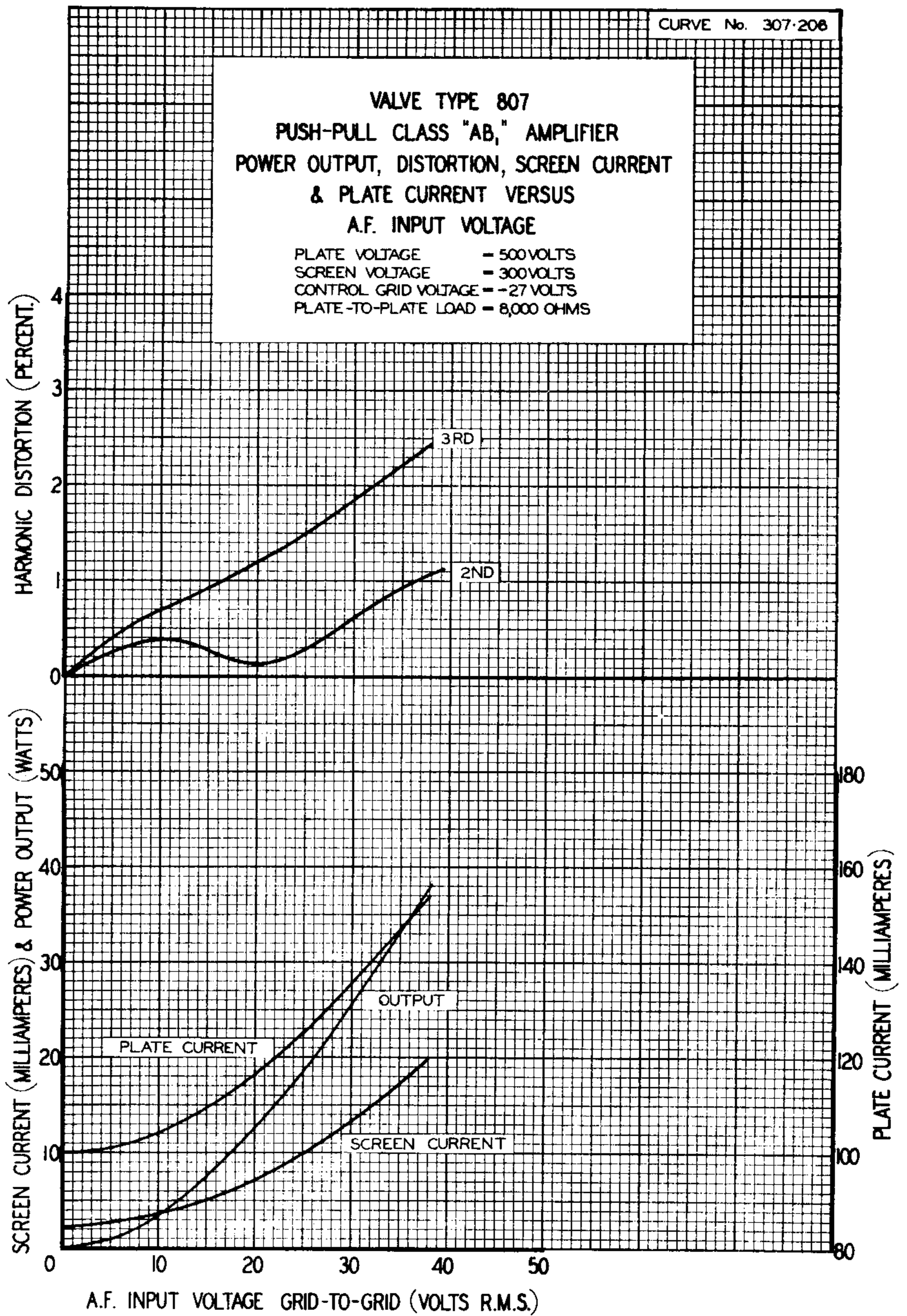

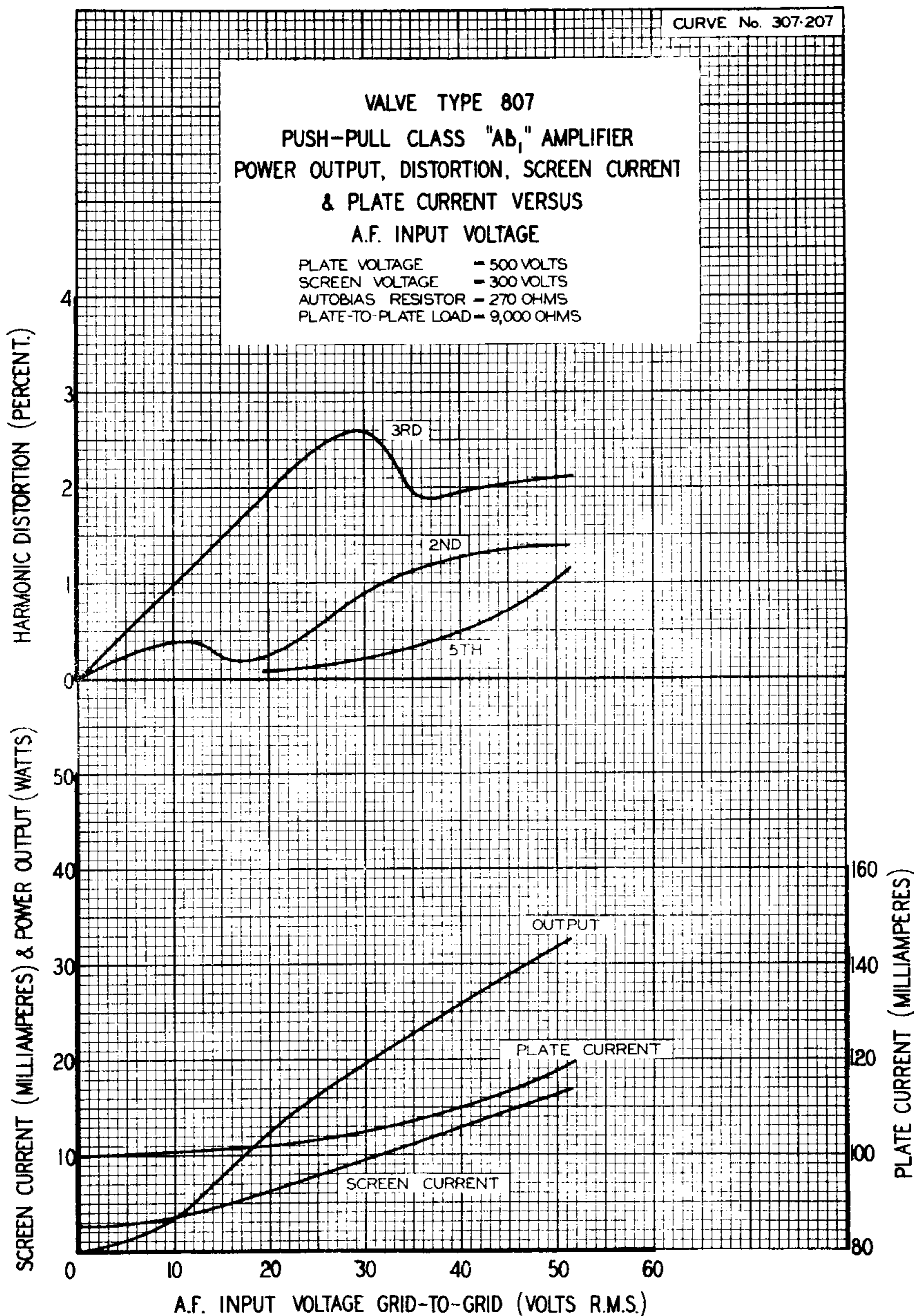



CURVE No. 307-208

VALVE TYPE 807
PUSH-PULL CLASS 'AB₁' AMPLIFIER
POWER OUTPUT, DISTORTION, SCREEN CURRENT
& PLATE CURRENT VERSUS
A.F. INPUT VOLTAGE

PLATE VOLTAGE = 600 VOLTS
SCREEN VOLTAGE = 300 VOLTS
CONTROL GRID VOLTAGE = -29.5 VOLTS
PLATE-TO-PLATE LOAD = 10,000 OHMS

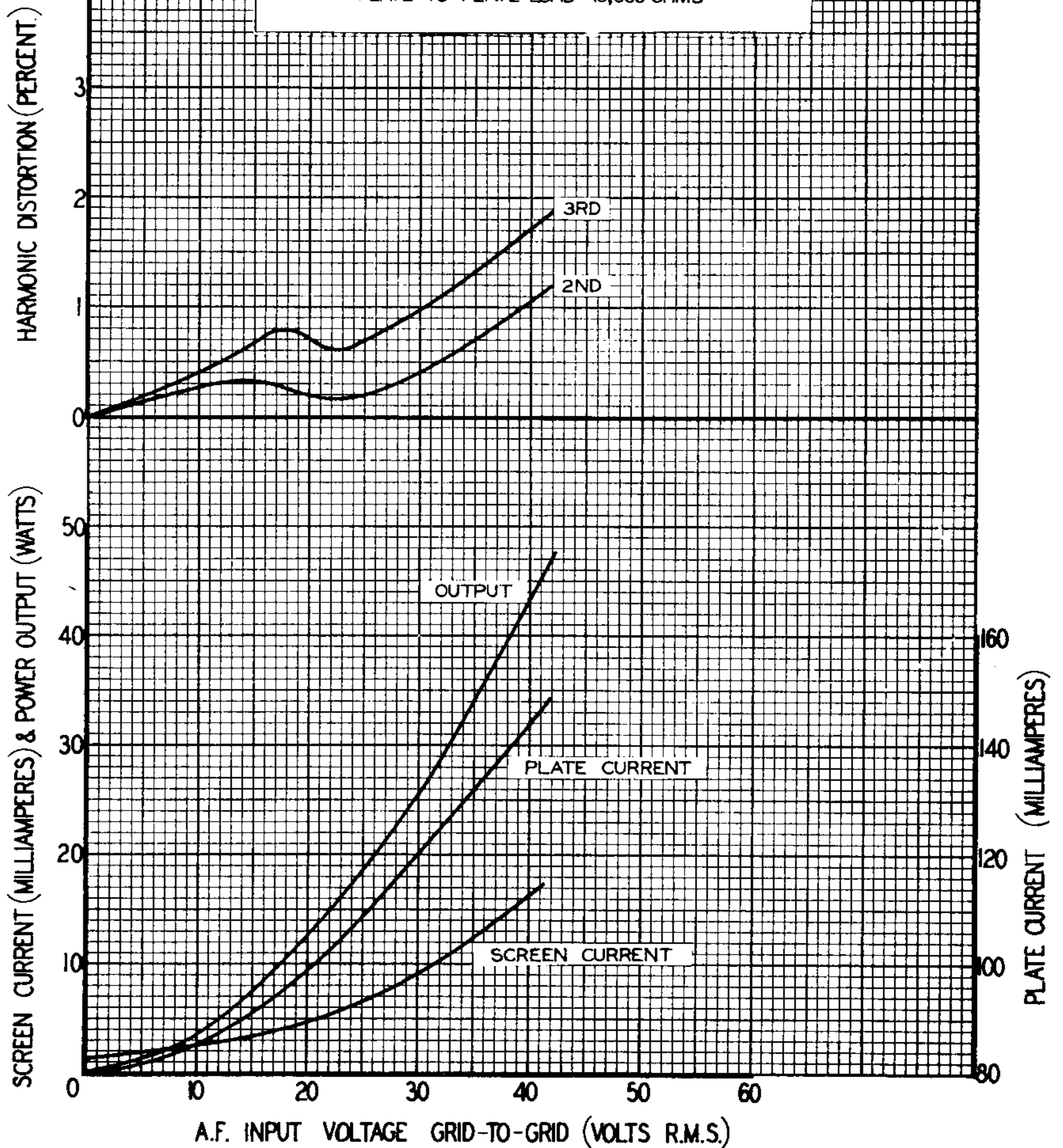

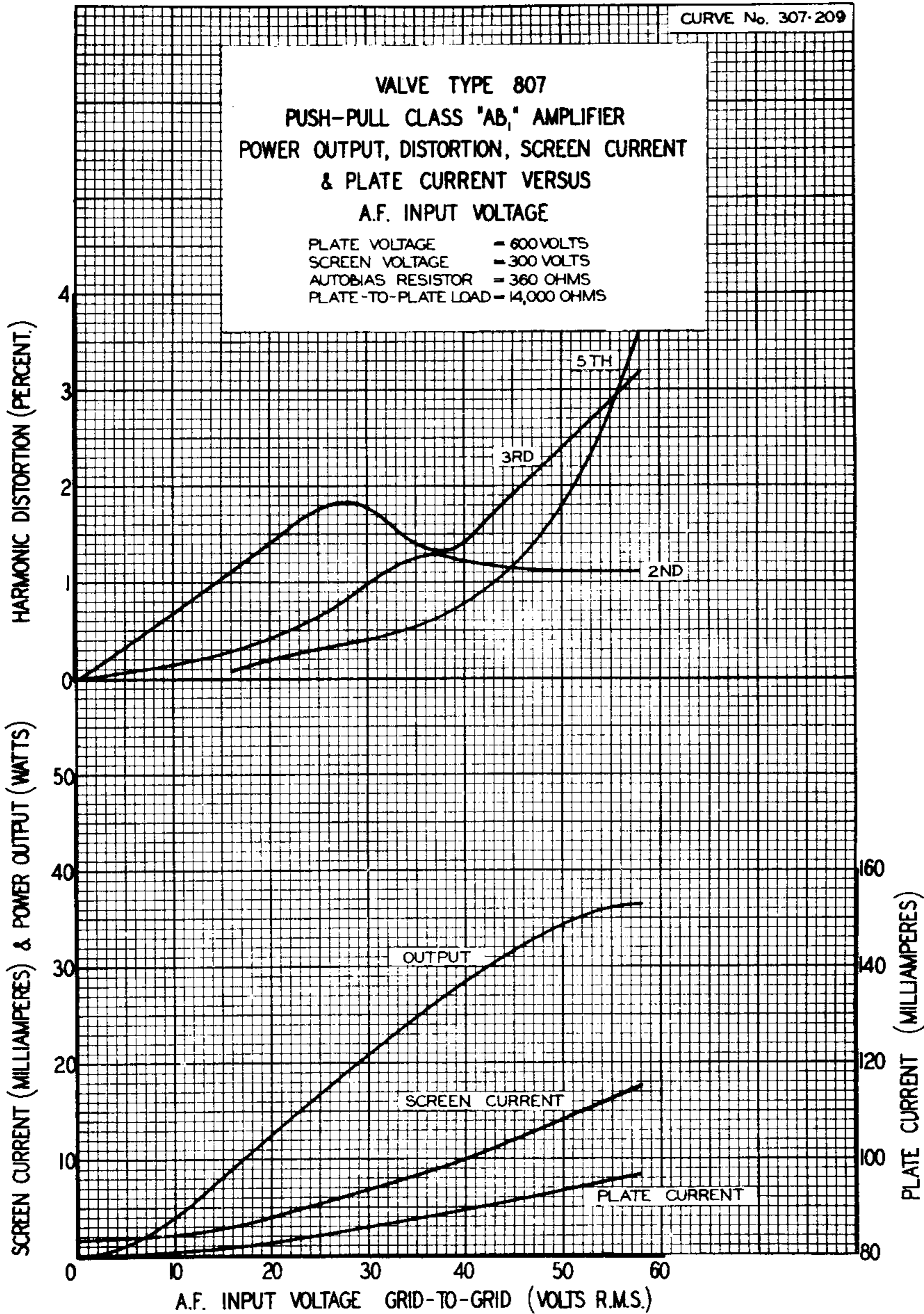

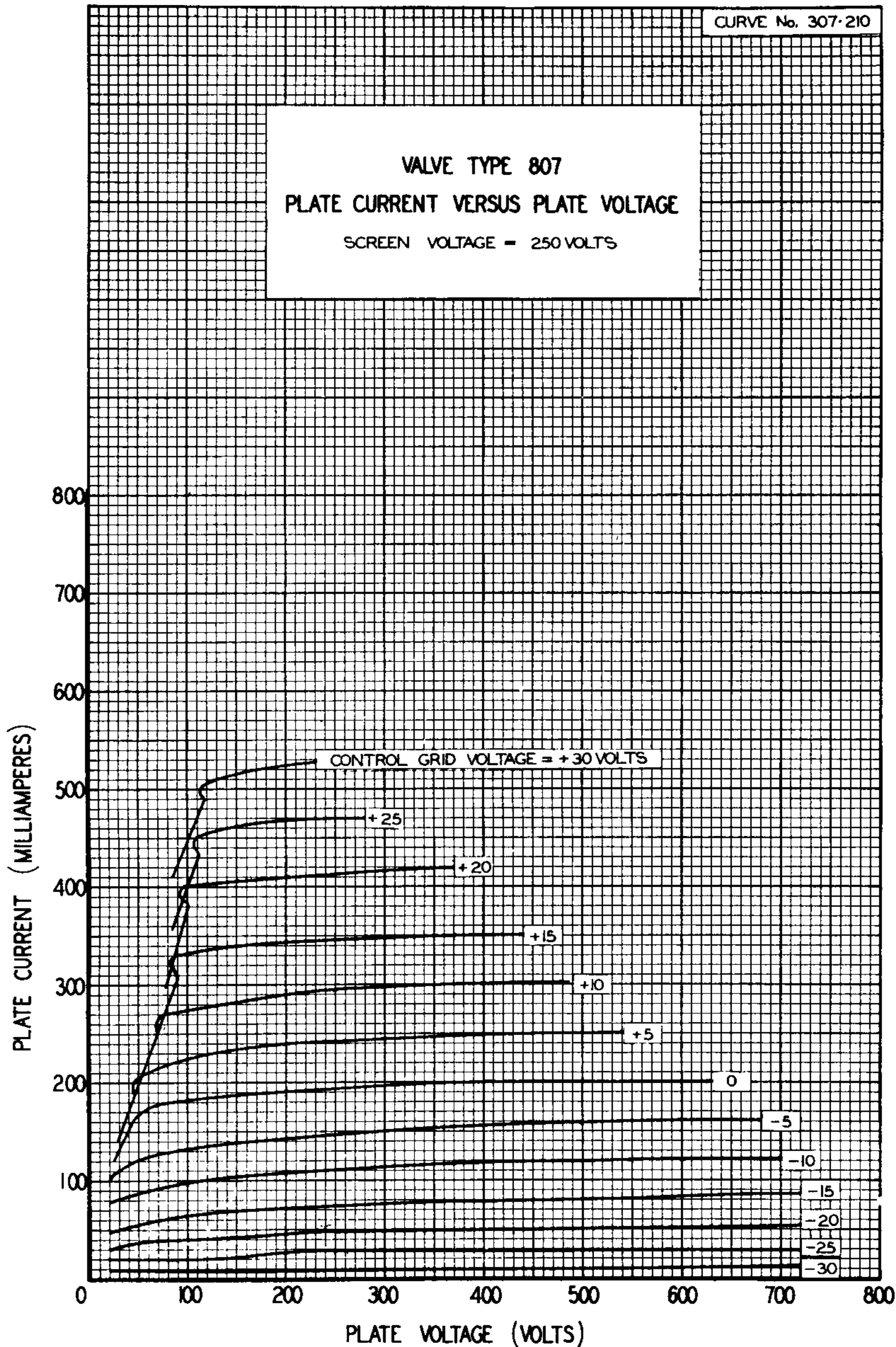



CURVE No. 307-211

VALVE TYPE 807
PLATE CURRENT VERSUS PLATE VOLTAGE
SCREEN VOLTAGE = 300 VOLTS

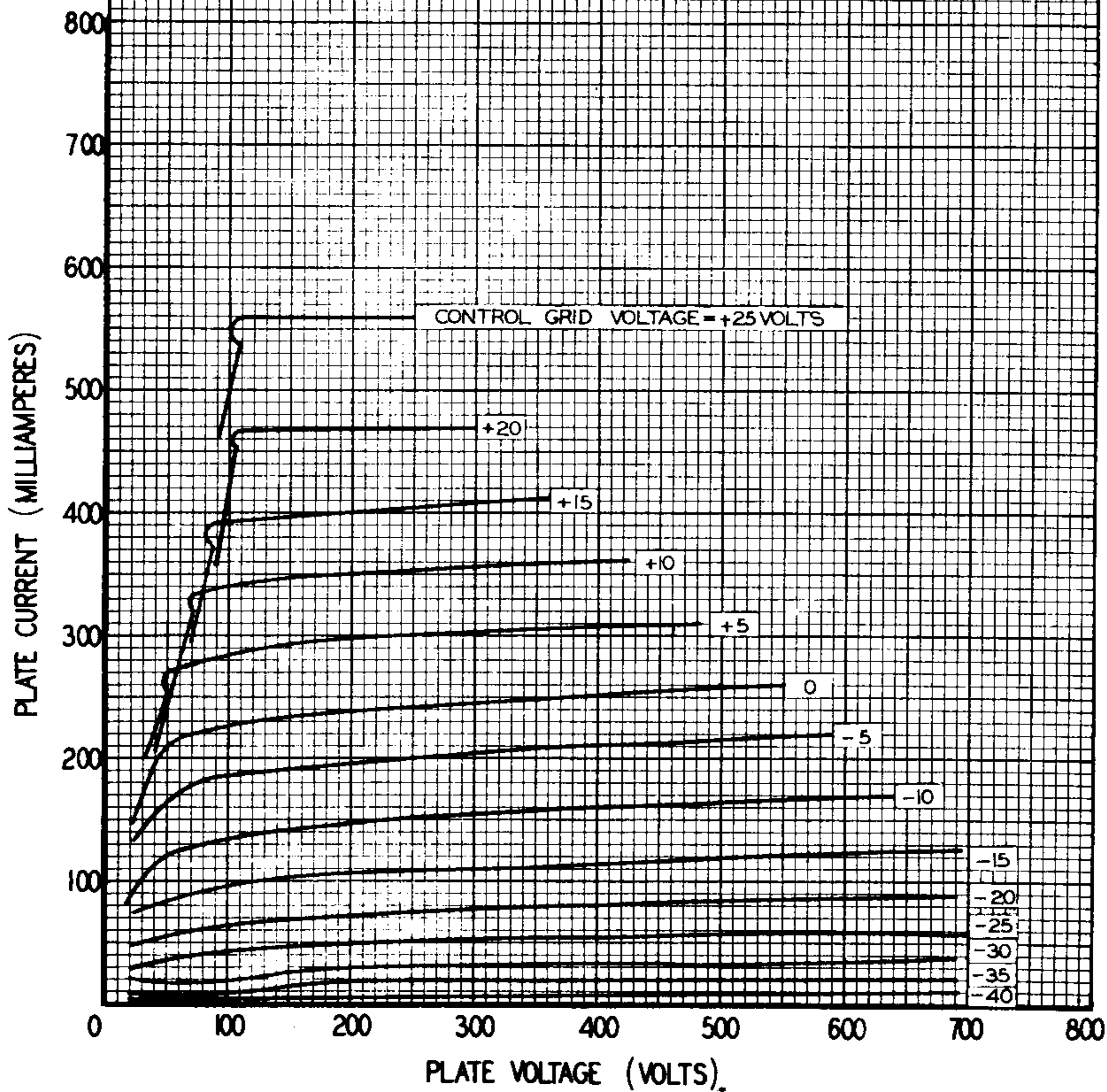

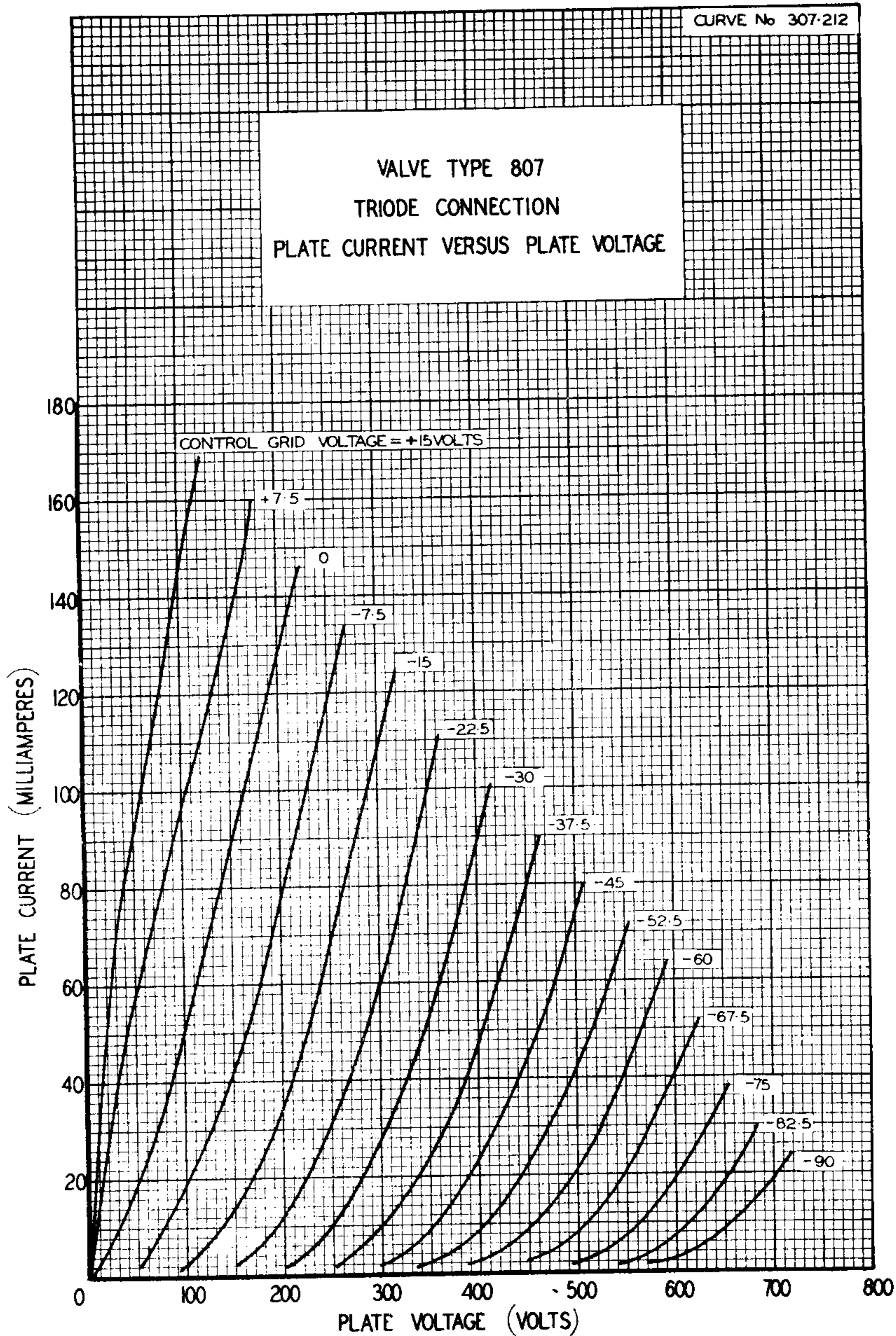



CURVE No. 307-213

VALVE TYPE 807
SCREEN CURRENT VERSUS PLATE VOLTAGE
SCREEN VOLTAGE = 250 VOLTS

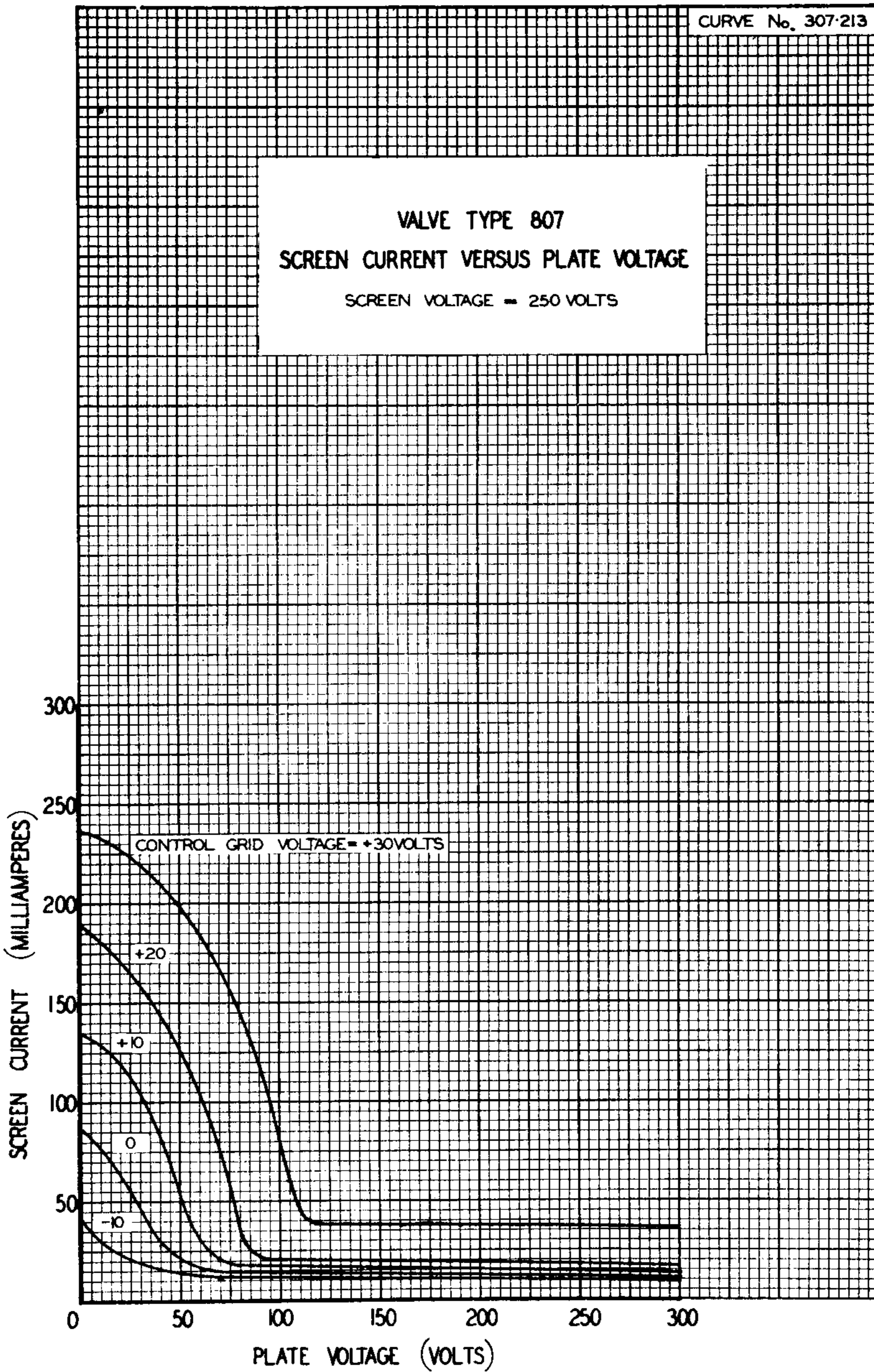



CURVE No 307-214

VALVE TYPE 807
SCREEN CURRENT VERSUS PLATE VOLTAGE
SCREEN VOLTAGE = 300 VOLTS

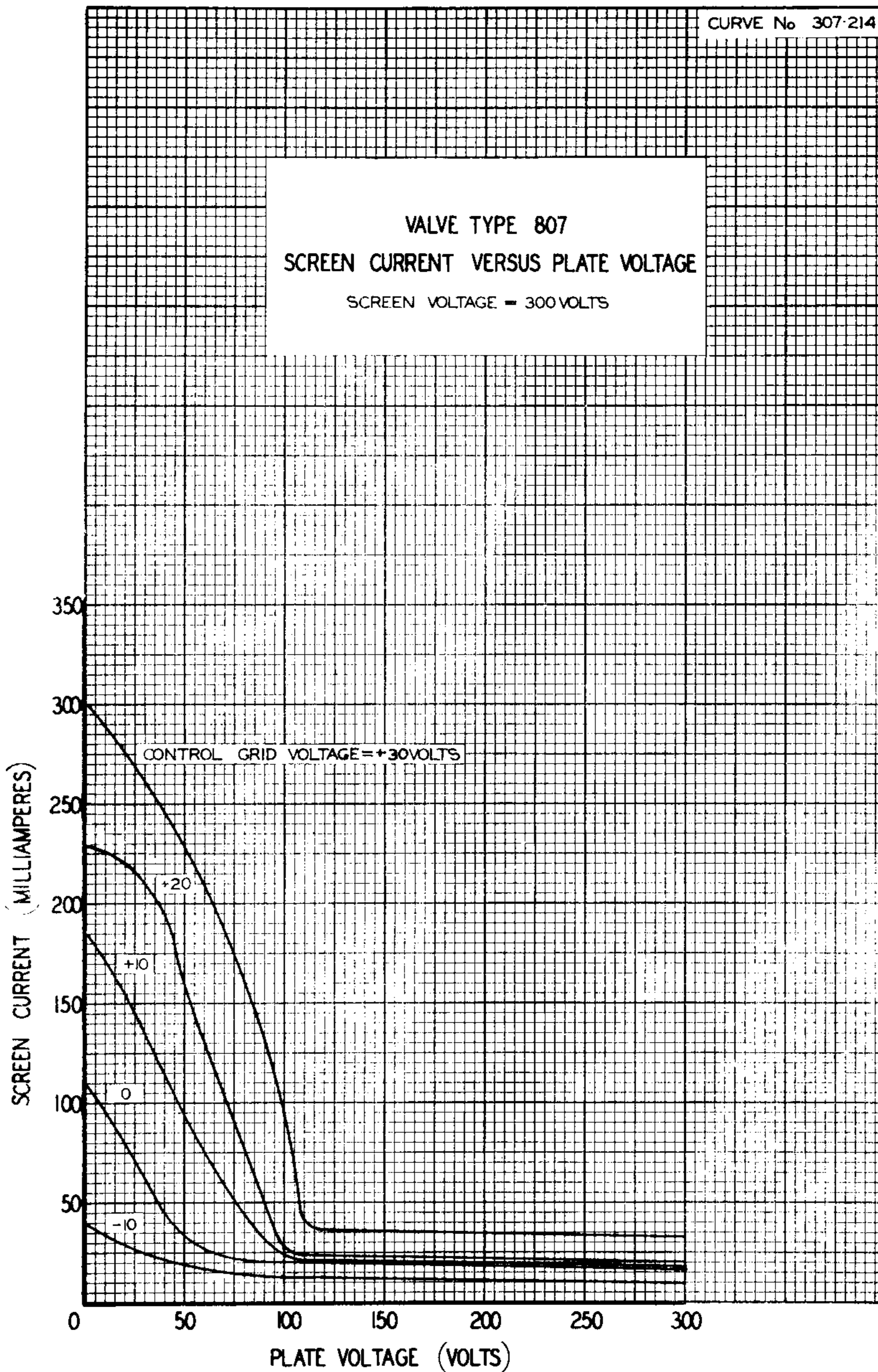

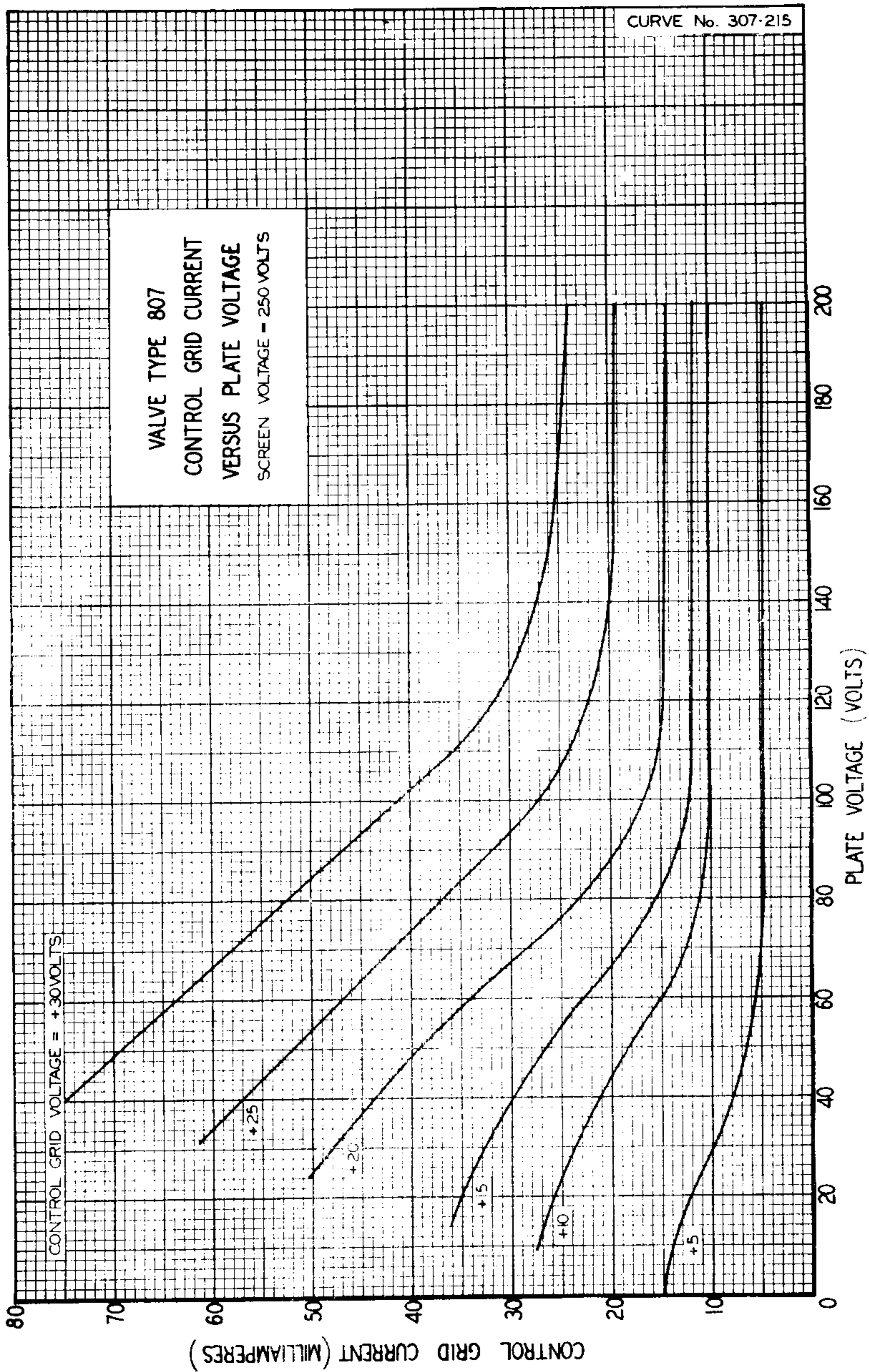

AN ITC
ASSOCIATE

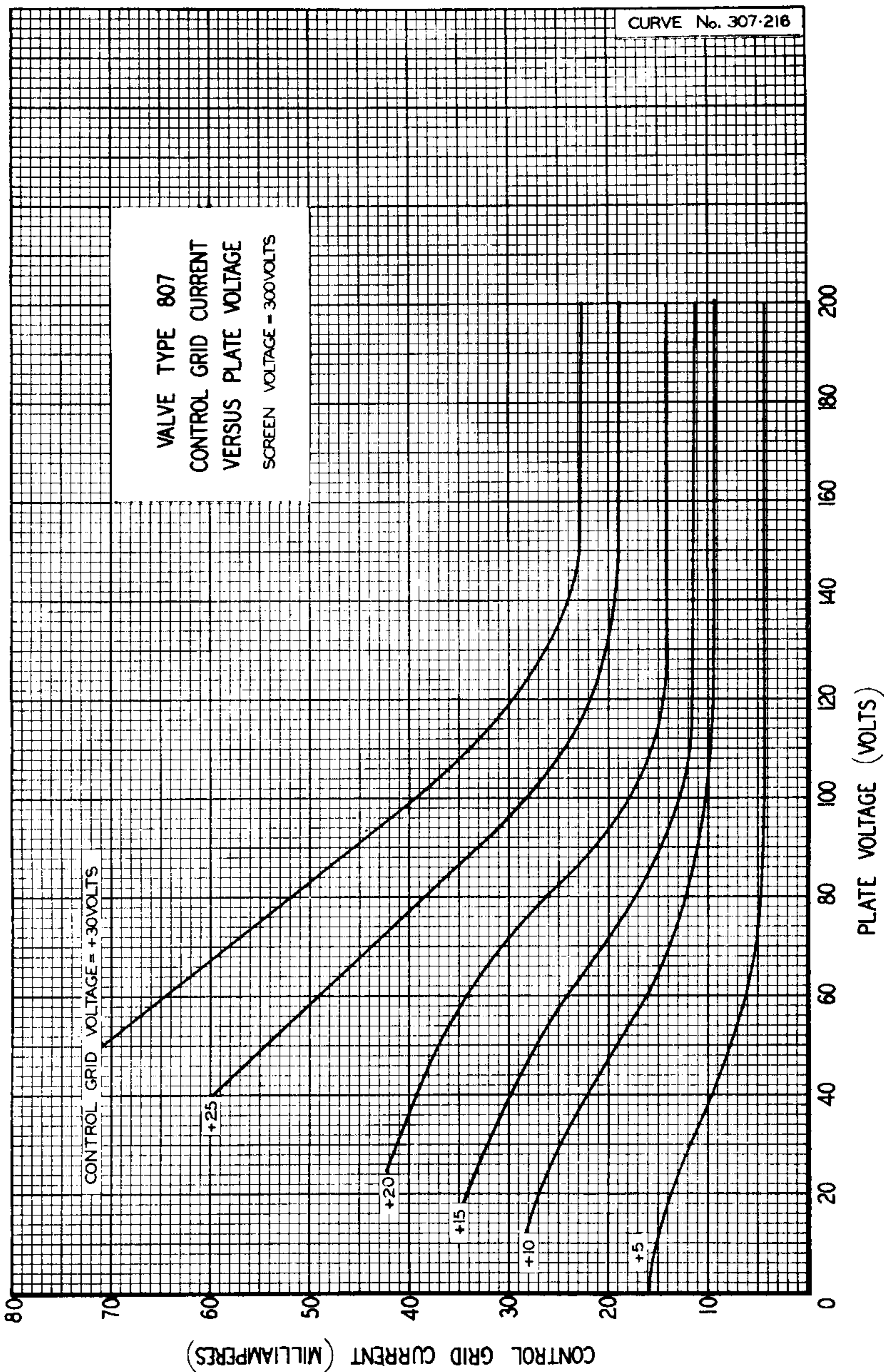

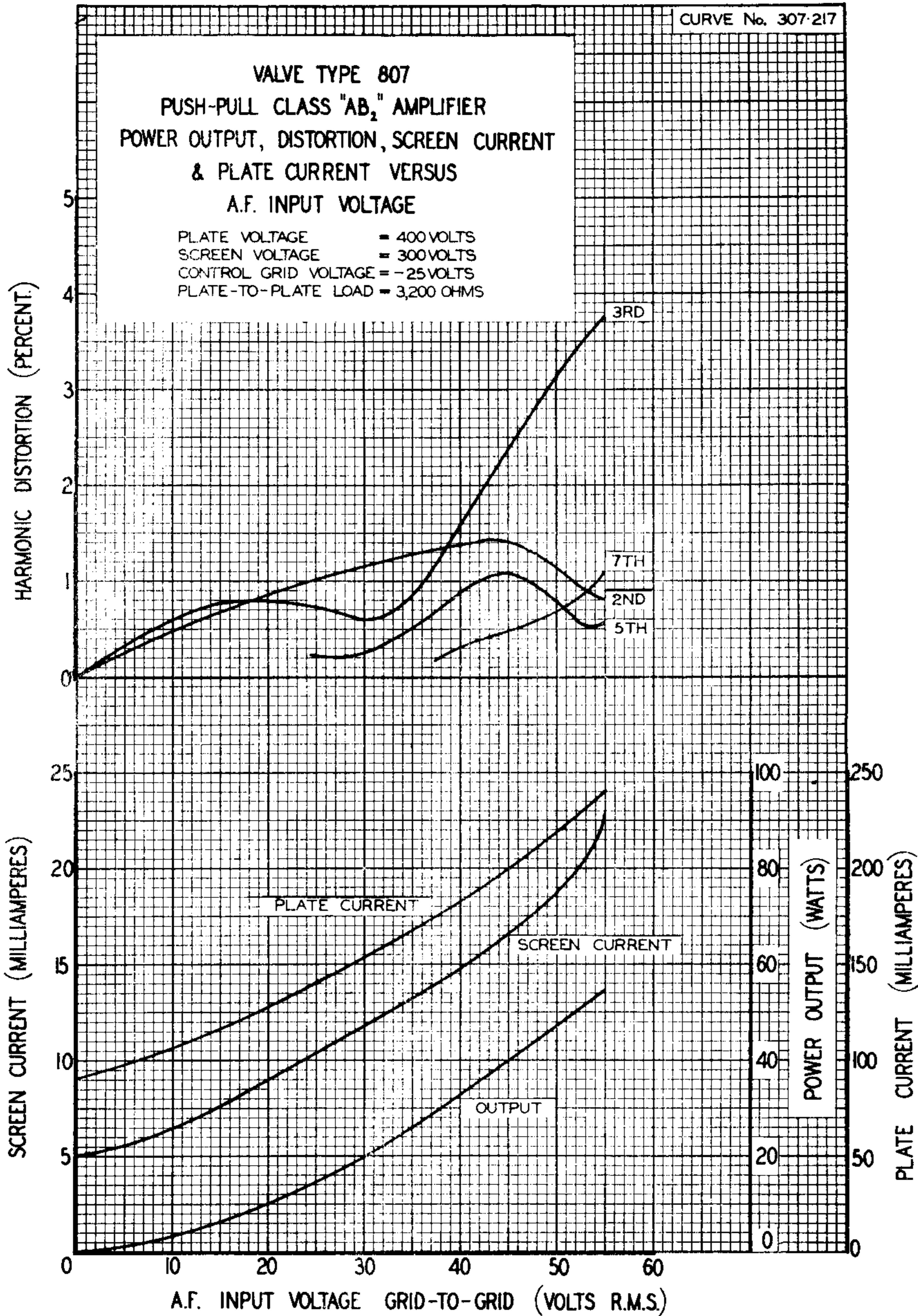

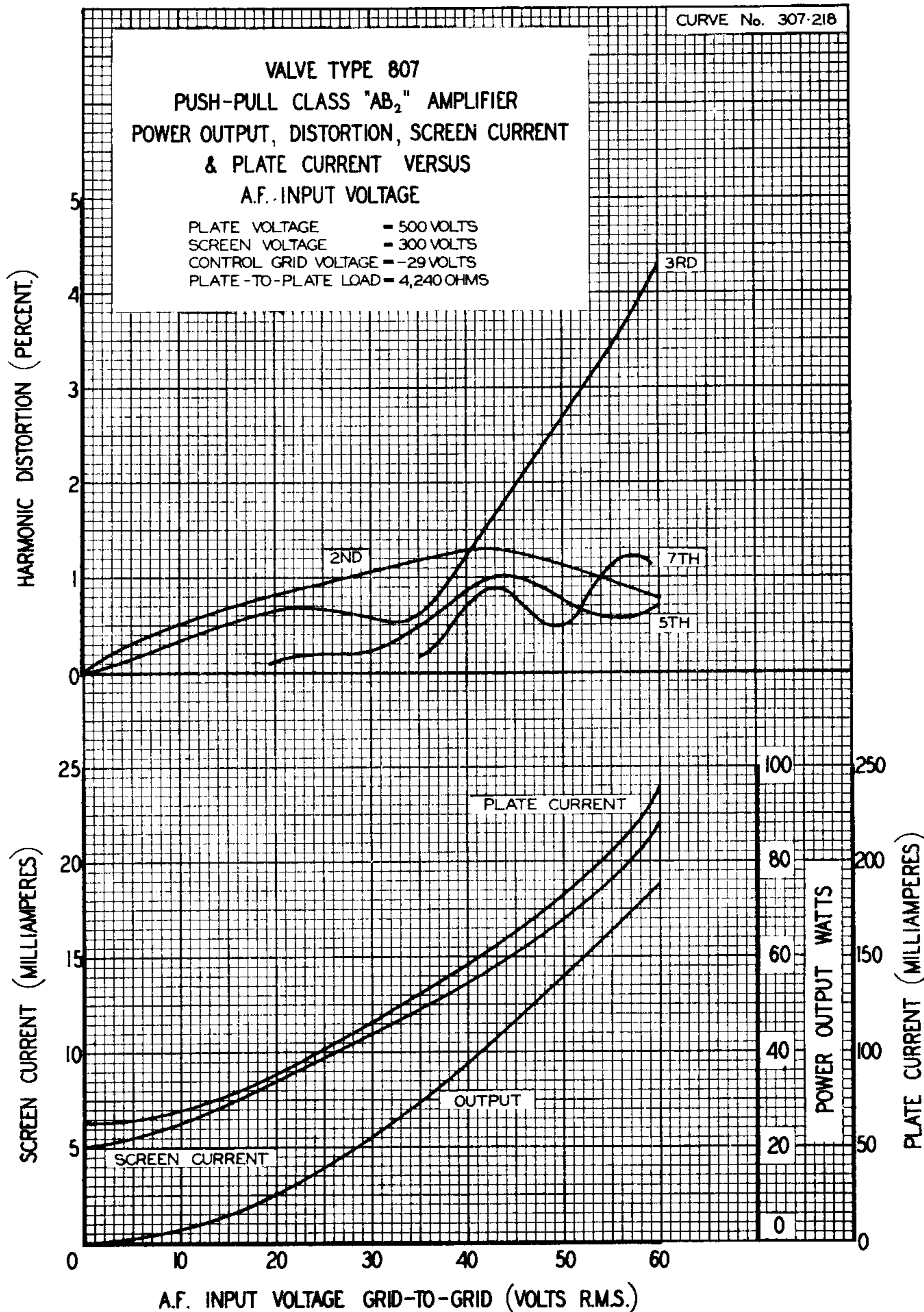



CURVE No. 307-219

VALVE TYPE 807
 PUSH-PULL CLASS "AB₂" AMPLIFIER
 POWER OUTPUT, DISTORTION, SCREEN CURRENT
 & PLATE CURRENT VERSUS
 A.F. INPUT VOLTAGE

PLATE VOLTAGE = 600 VOLTS
 SCREEN VOLTAGE = 300 VOLTS
 CONTROL GRID VOLTAGE = -30 VOLTS
 PLATE-TO-PLATE LOAD = 6,400 OHMS

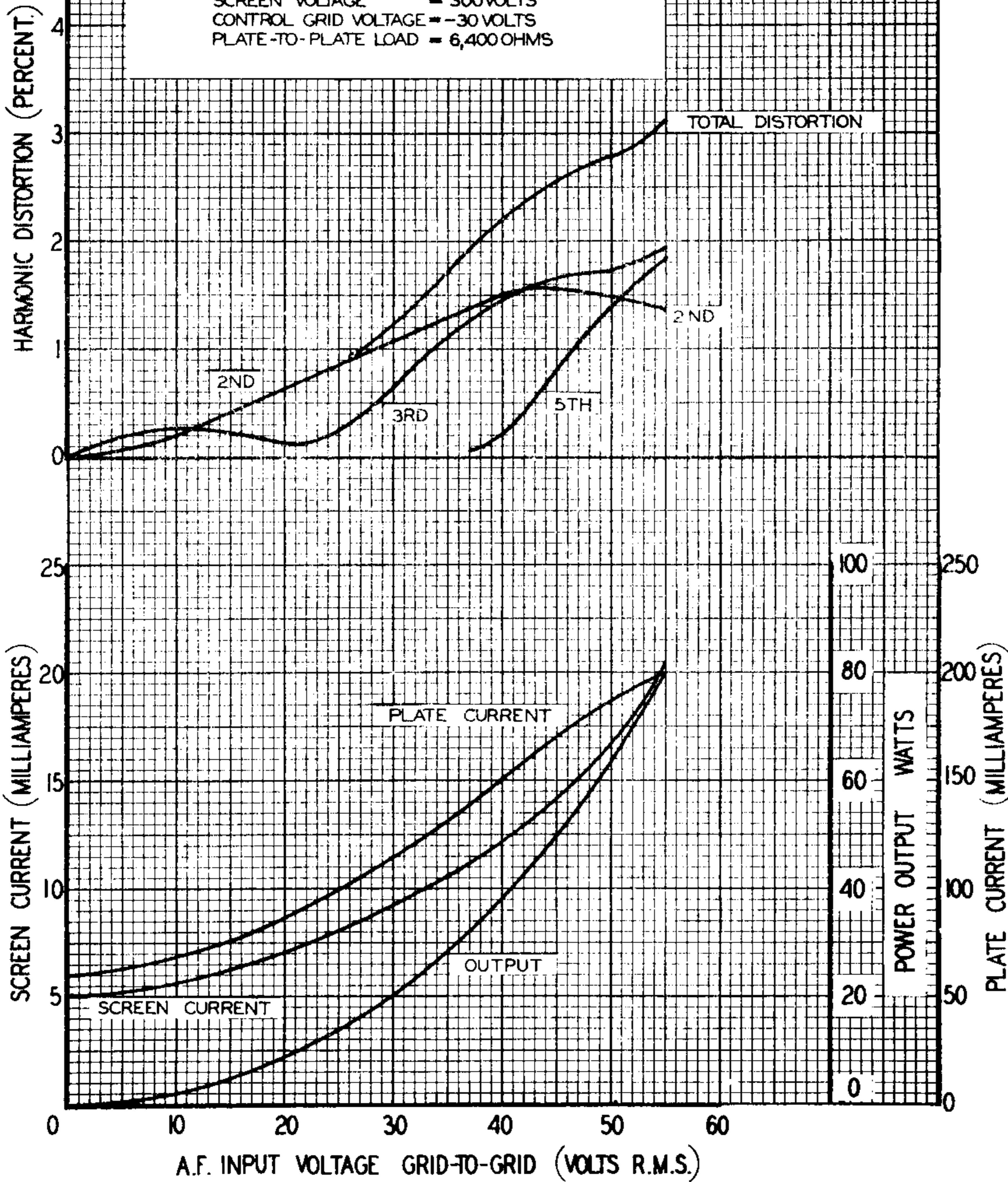

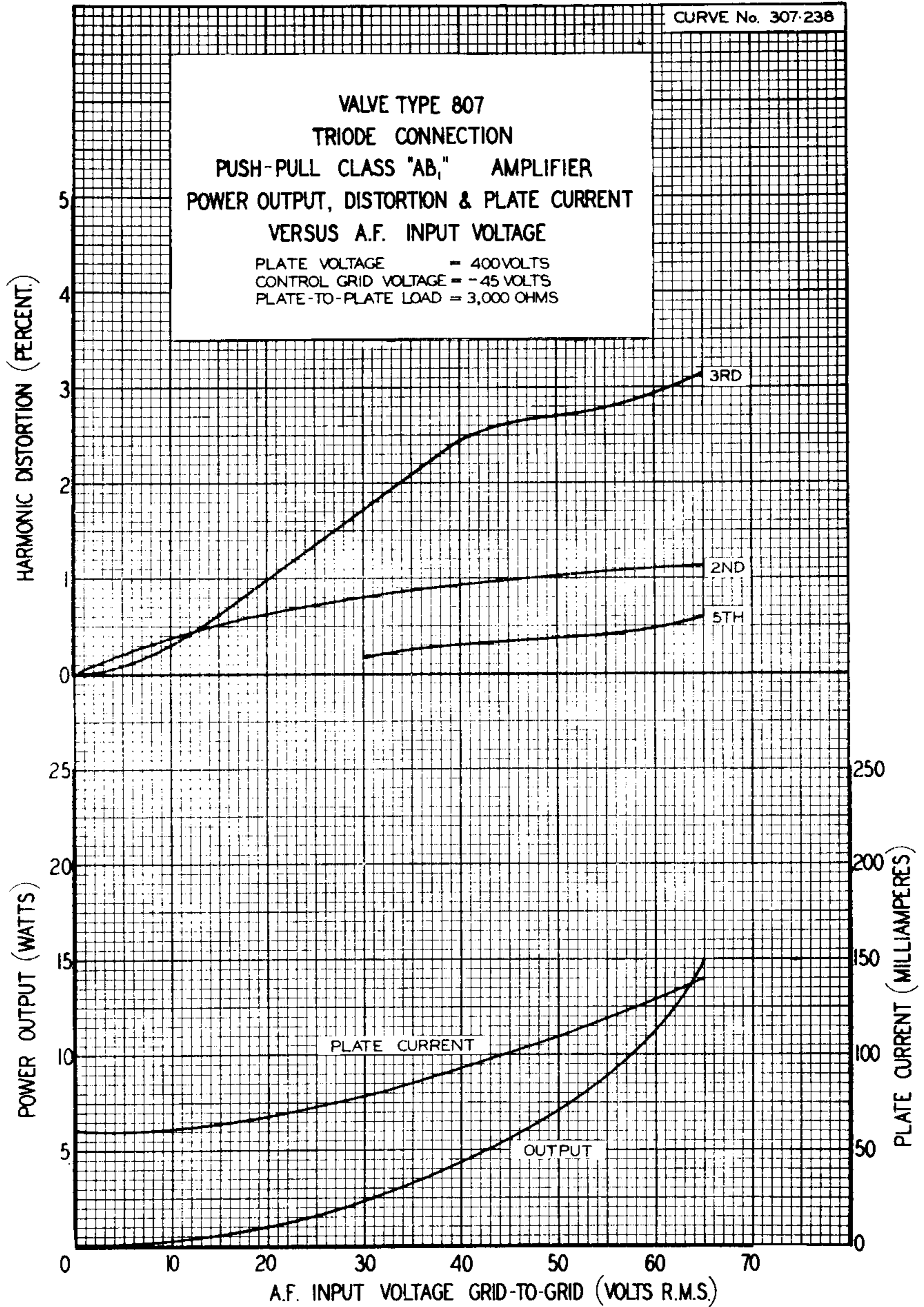



CURVE No. 307-331

VALVE TYPE 807
 TRIODE CONNECTION
 CLASS "A" AMPLIFIER
 POWER OUTPUT & DISTORTION
 VERSUS A.F. INPUT VOLTAGE

PLATE VOLTAGE = 250 VOLTS
 CONTROL GRID VOLTAGE = -20 VOLTS
 PLATE CURRENT = 40-44 mA
 PLATE LOAD = 5,000 OHMS

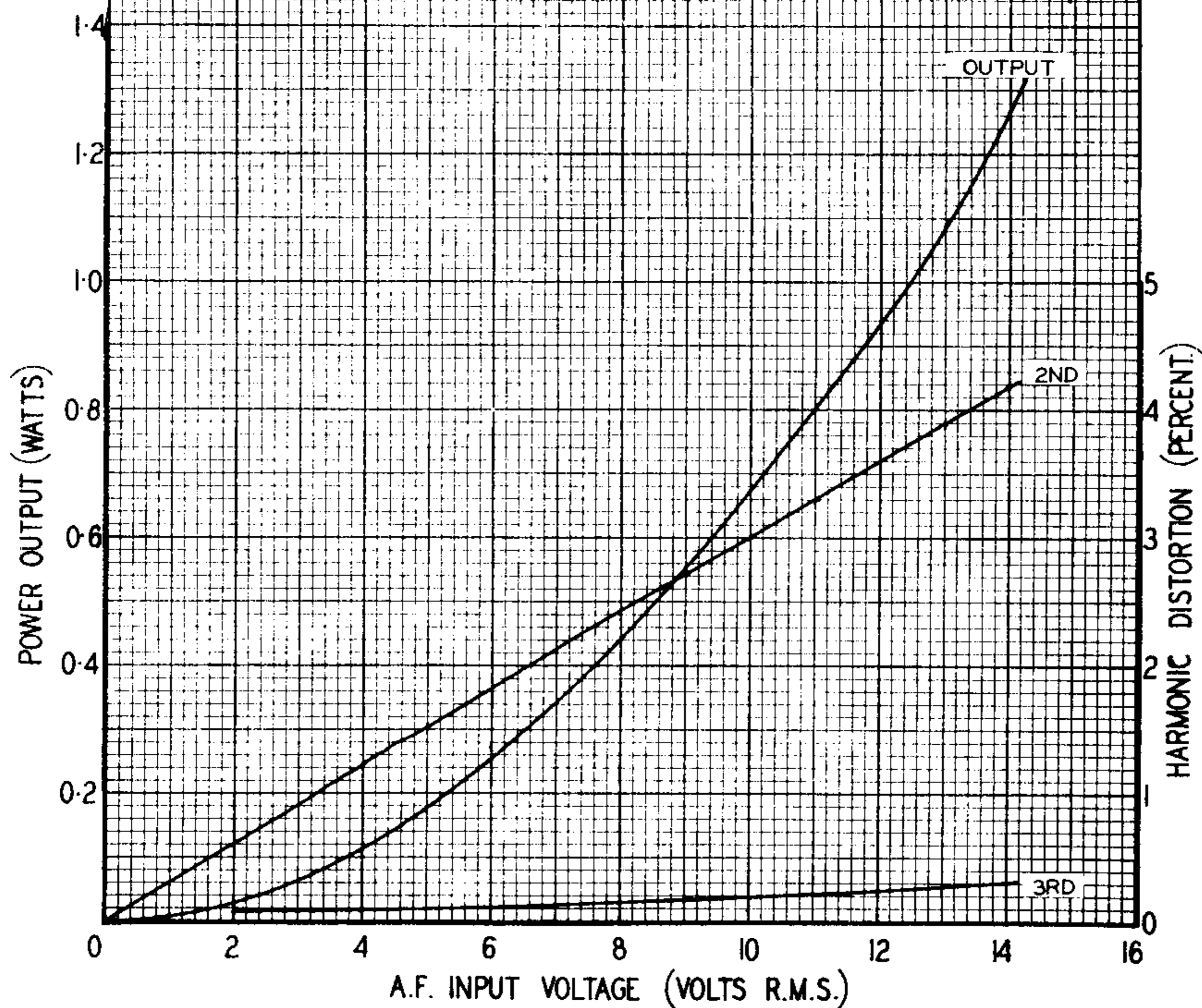

AN I.T.C. ASSOCIATE



CURVE No. 307-332

VALVE TYPE 807
TRIODE CONNECTION
CLASS 'A' AMPLIFIER
POWER OUTPUT & DISTORTION
VERSUS A.F. INPUT VOLTAGE

PLATE VOLTAGE = 250 VOLTS
AUTOBIAS RESISTOR = 500 OHMS
PLATE CURRENT = 40-41 mA
PLATE LOAD = 6,000 OHMS

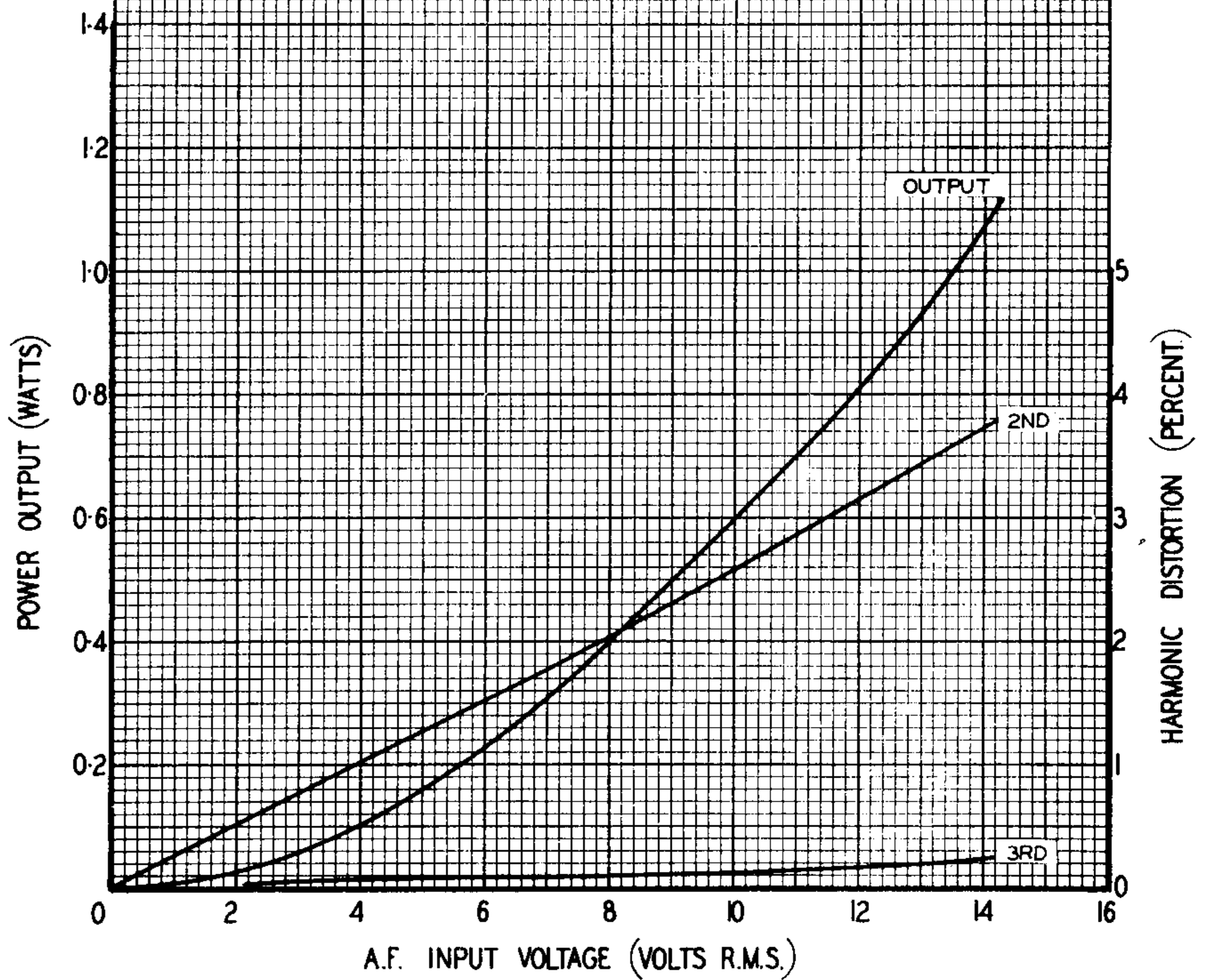



CURVE No. 307-333

VALVE TYPE 807
 TRIODE CONNECTION
 PUSH-PULL CLASS "A" AMPLIFIER
 POWER OUTPUT & DISTORTION
 VERSUS A.F. INPUT VOLTAGE

PLATE VOLTAGE = 250 VOLTS
 AUTOBIAS RESISTOR = 250 OHMS
 PLATE CURRENT = 80-84 mA
 PLATE-TO-PLATE LOAD = 5,000 OHMS

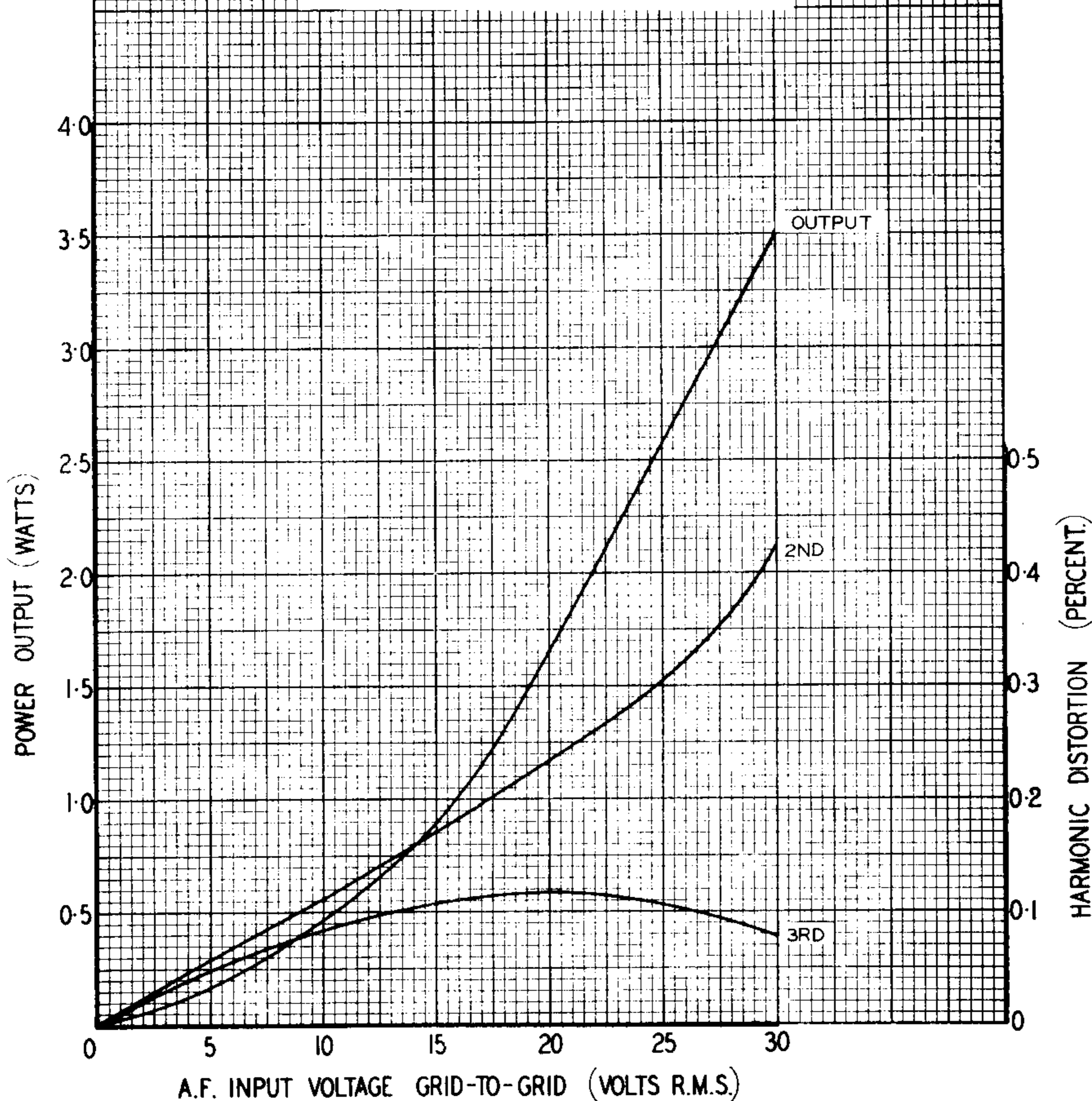

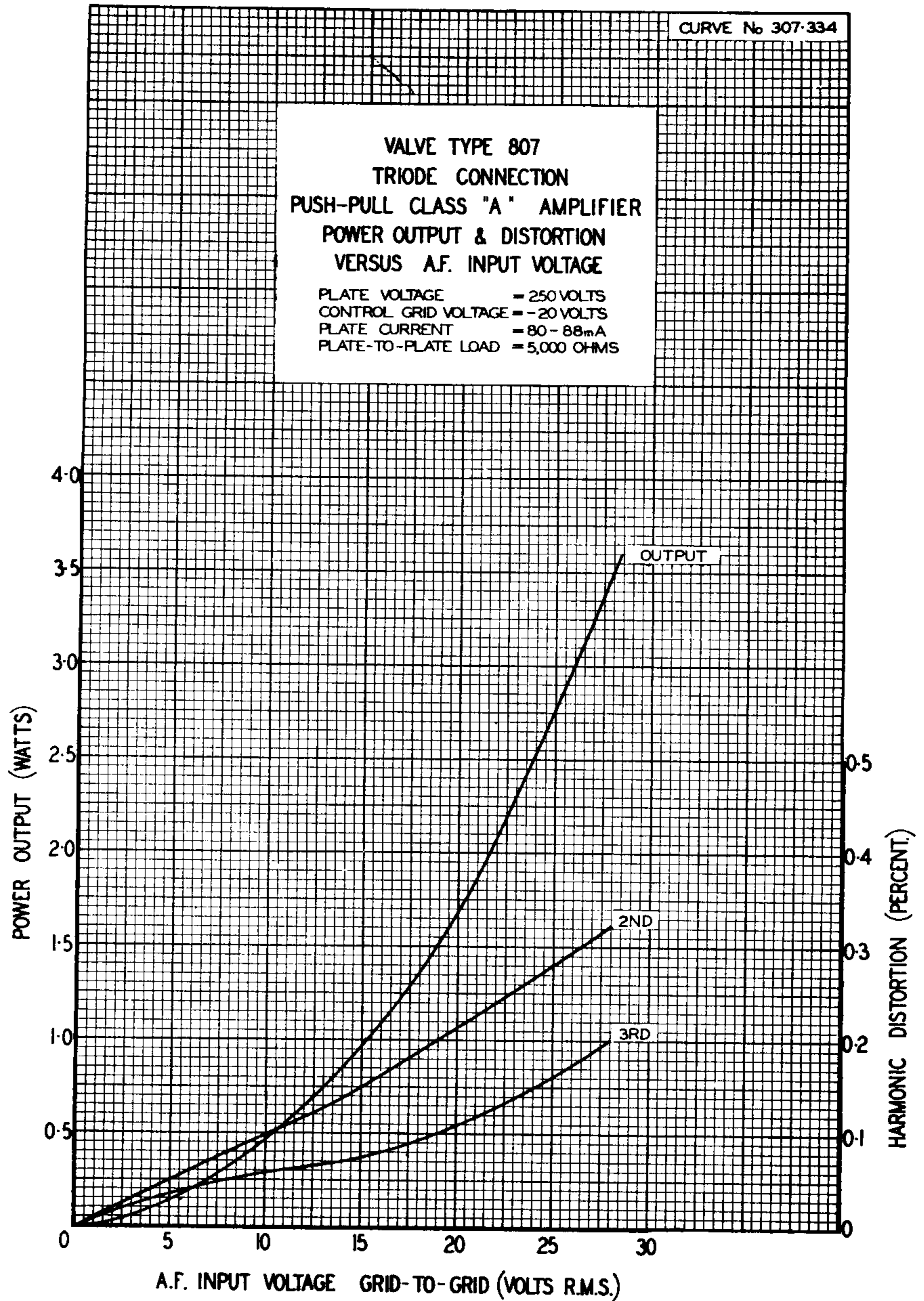

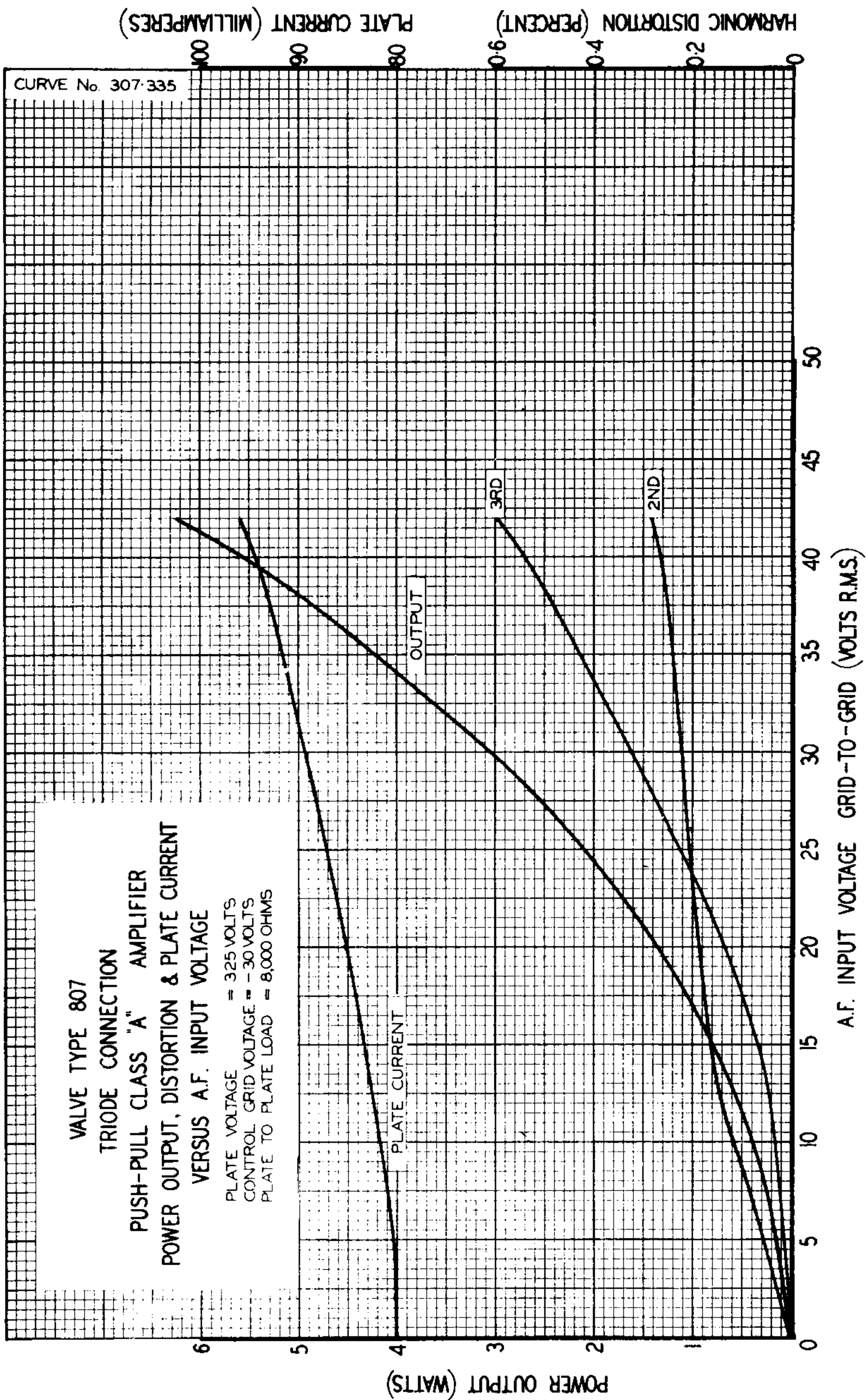

AN I.T.E.T. ASSOCIATE

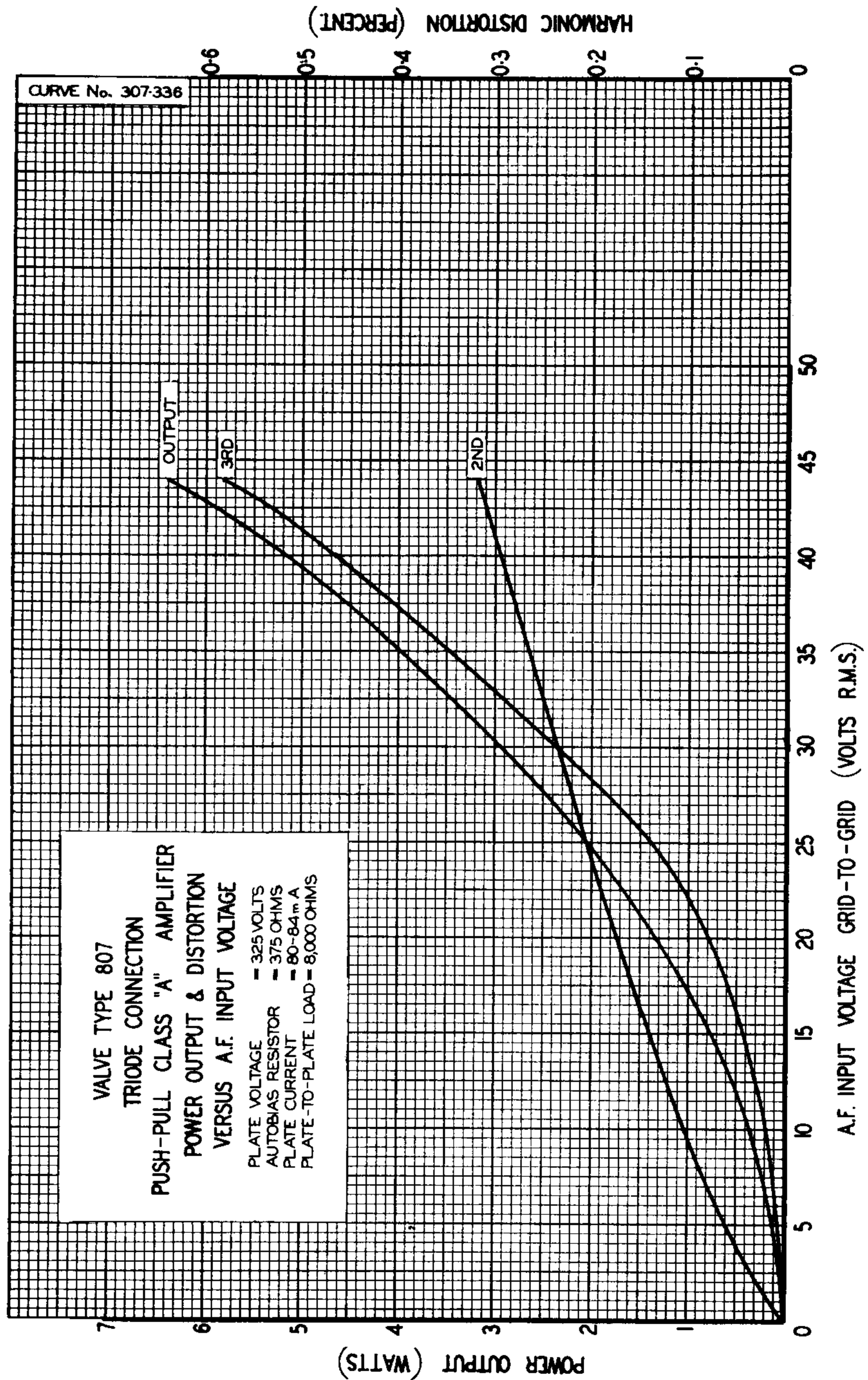



CURVE No. 307-337

VALVE TYPE 807
 CLASS "A" AMPLIFIER
 POWER OUTPUT, DISTORTION, SCREEN CURRENT
 & PLATE CURRENT VERSUS
 A.F. INPUT VOLTAGE

PLATE VOLTAGE = 250 VOLTS
 SCREEN VOLTAGE = 250 VOLTS
 CONTROL GRID VOLTAGE = -14 VOLTS
 PLATE LOAD = 2,500 OHMS

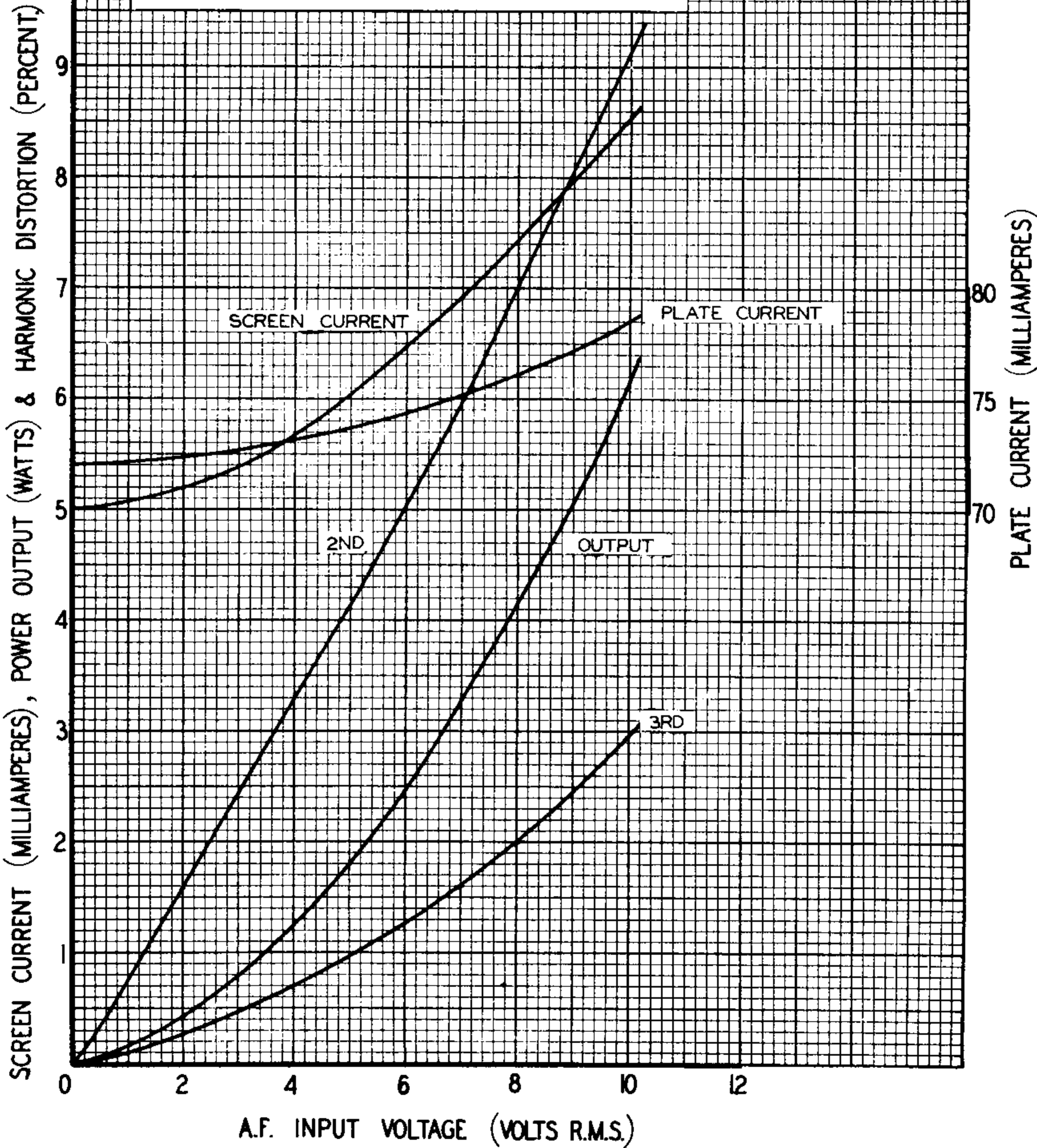

AN ITC
 ASSOCIATE

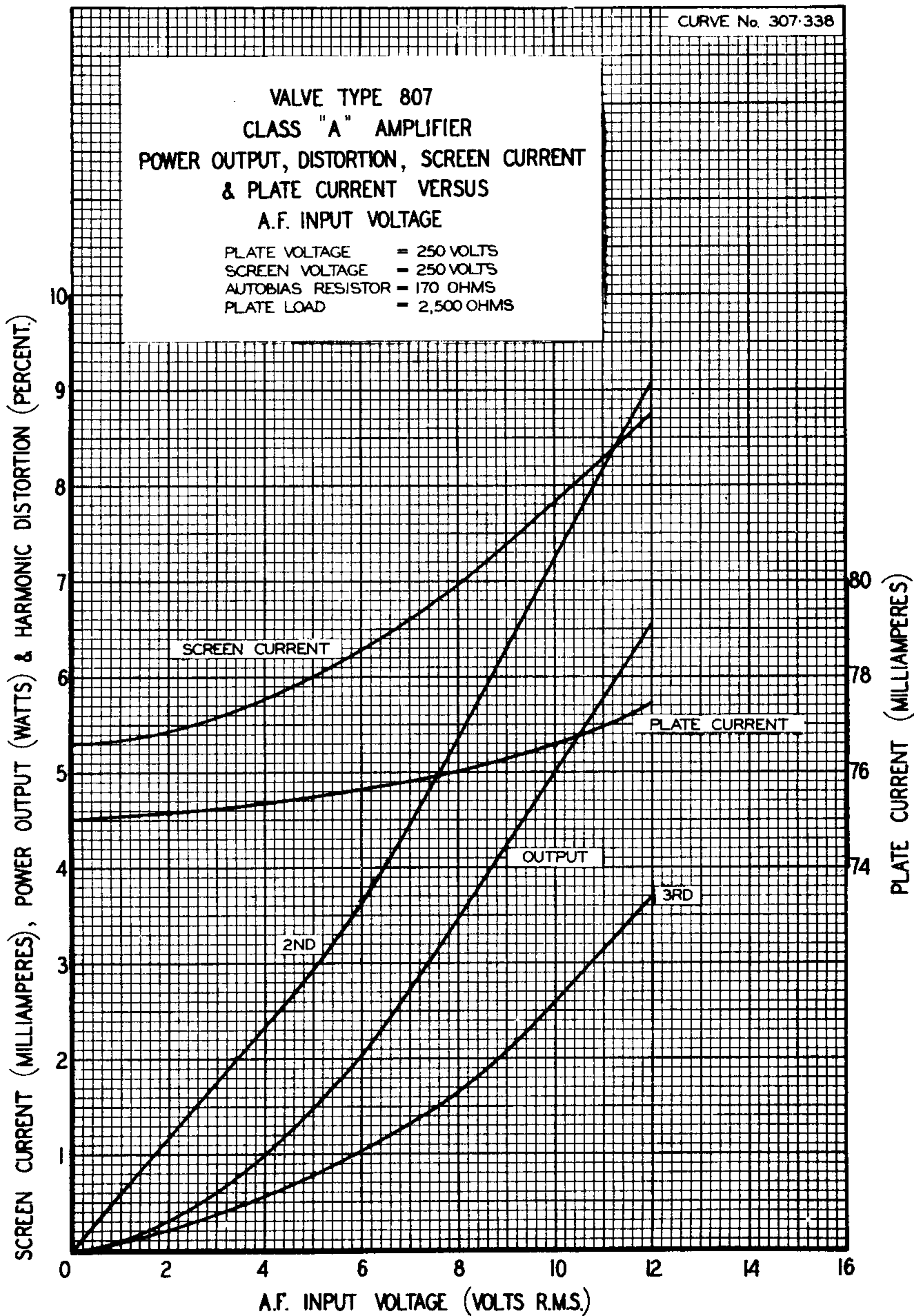

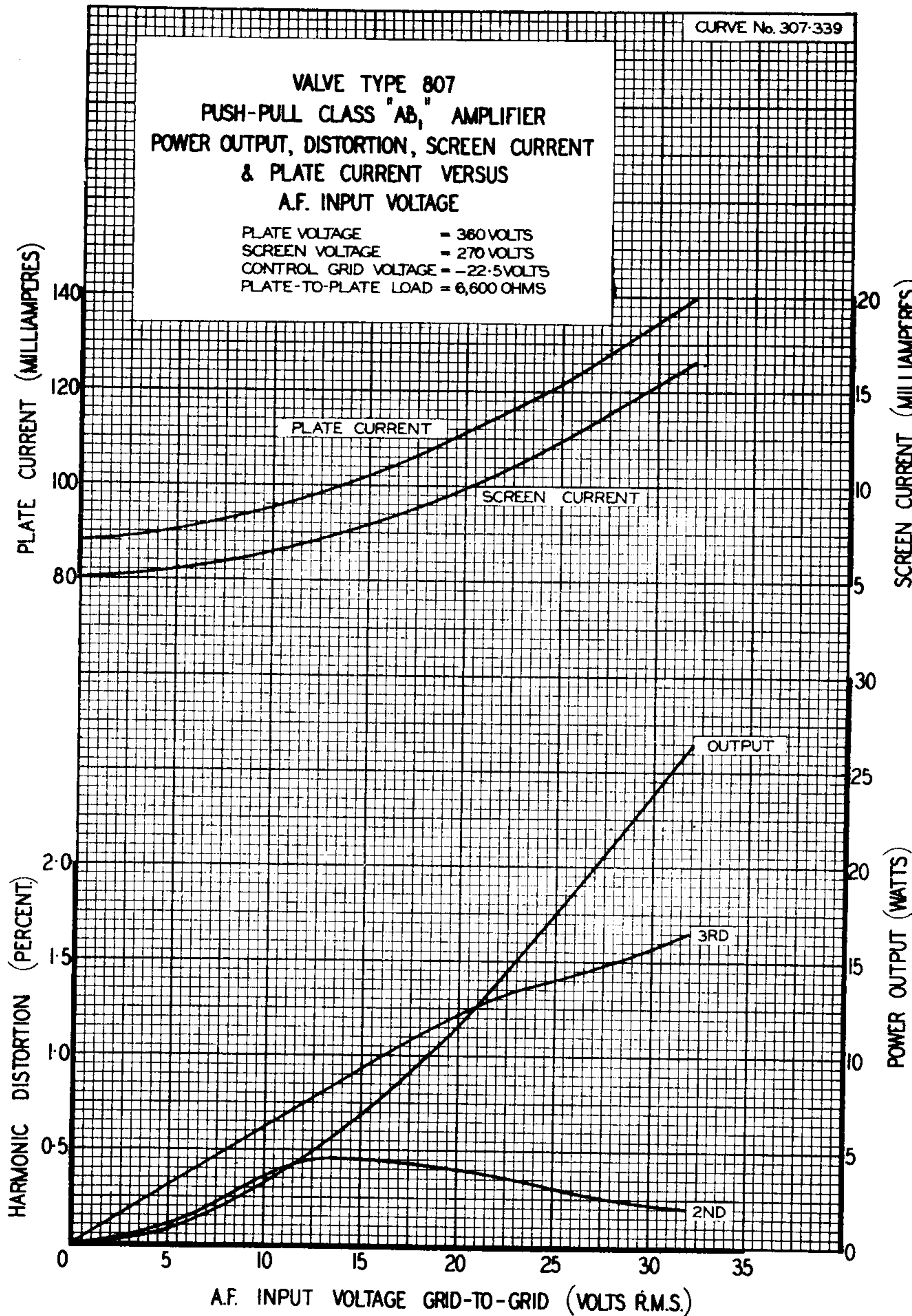
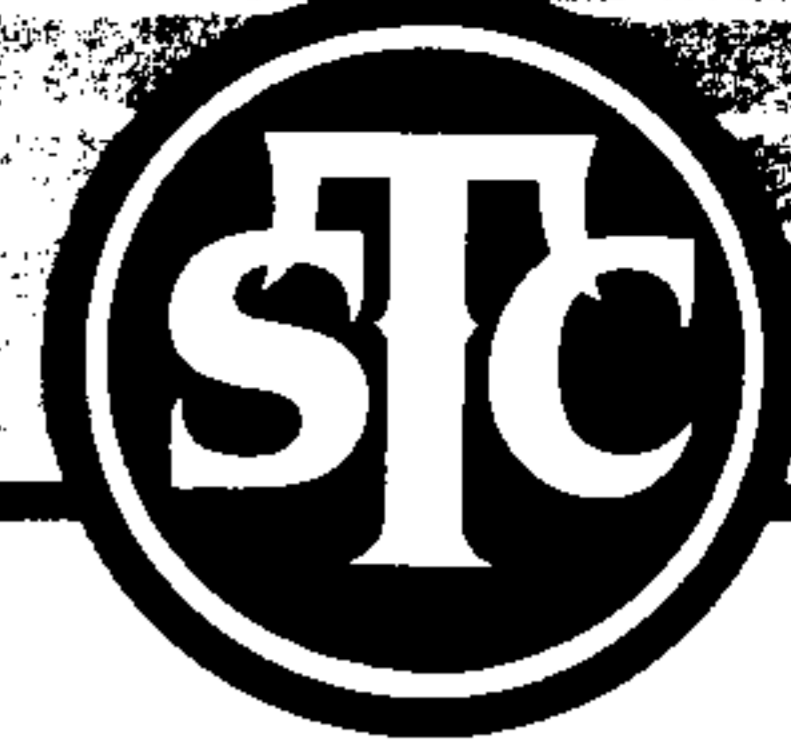

AN I.T.C. ASSOCIATE



SCREEN CURRENT (MILLIAMPERES) & POWER OUTPUT (WATTS)

CURVE No. 307-340

PLATE CURRENT MILLIAMPERES

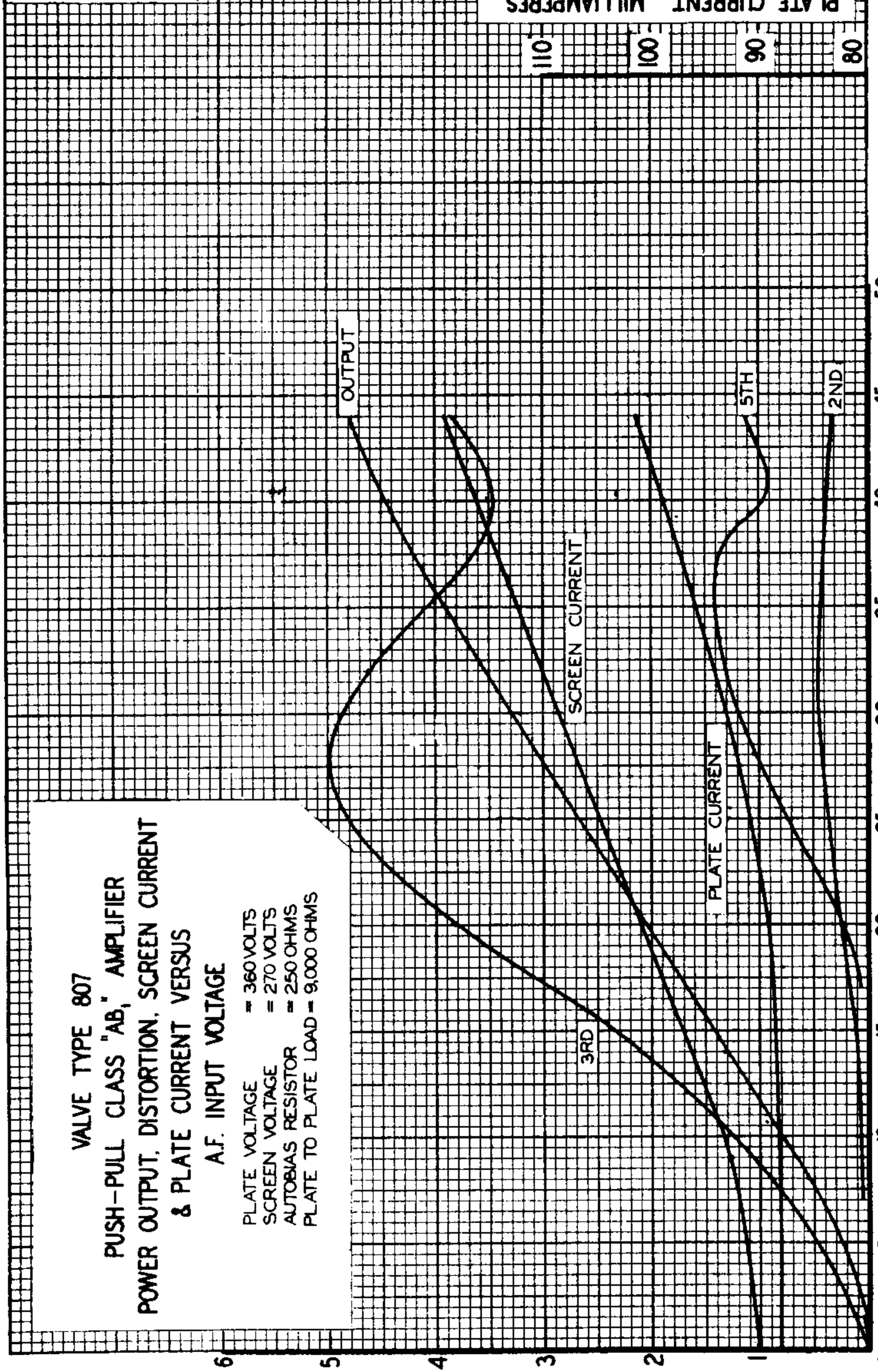

A.F. INPUT VOLTAGE GRID-TO-GRID (VOLTS R.M.S.)



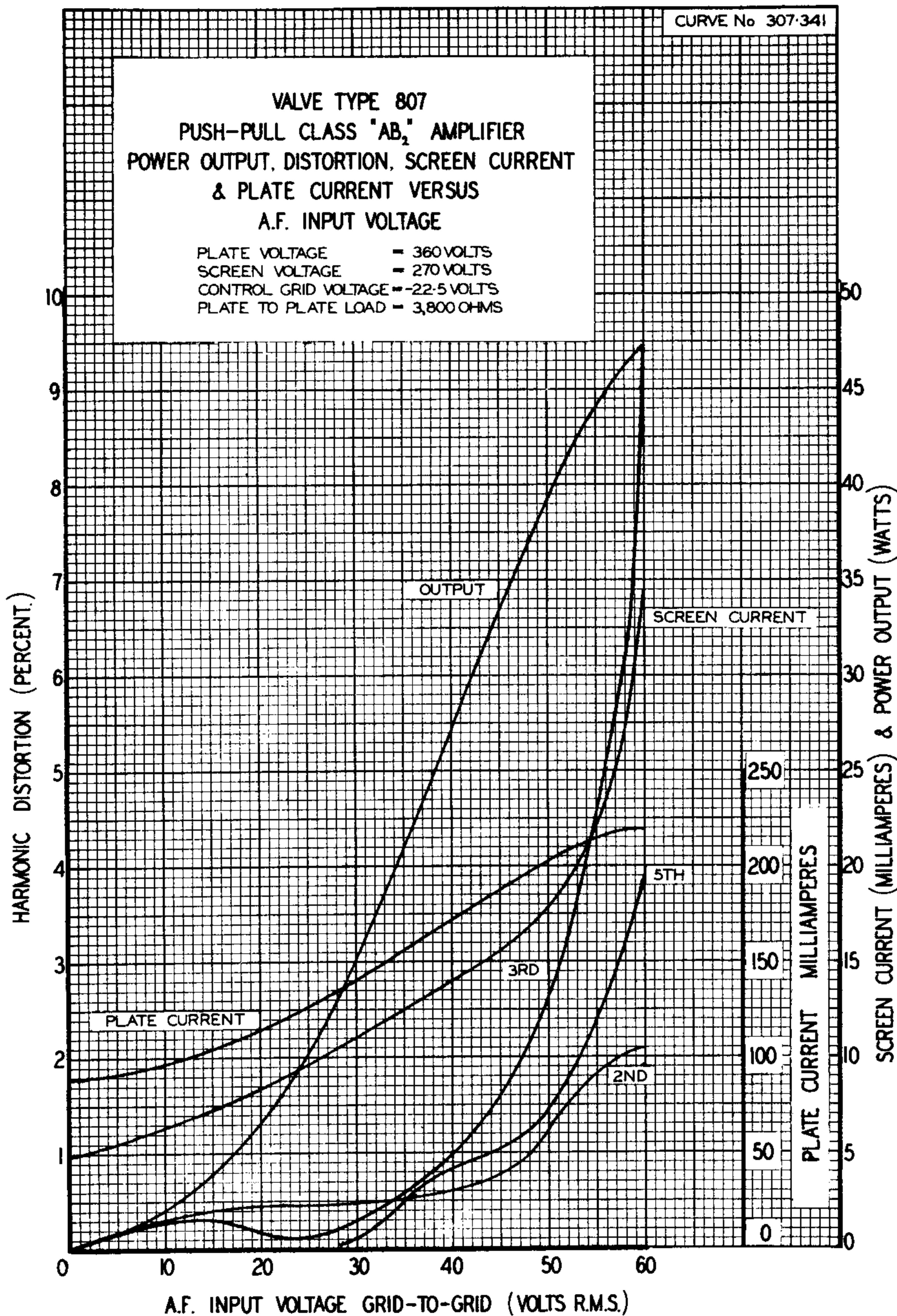

AN I.T.C.T. ASSOCIATE



75 WATT CLASS 'AB2' AMPLIFIER

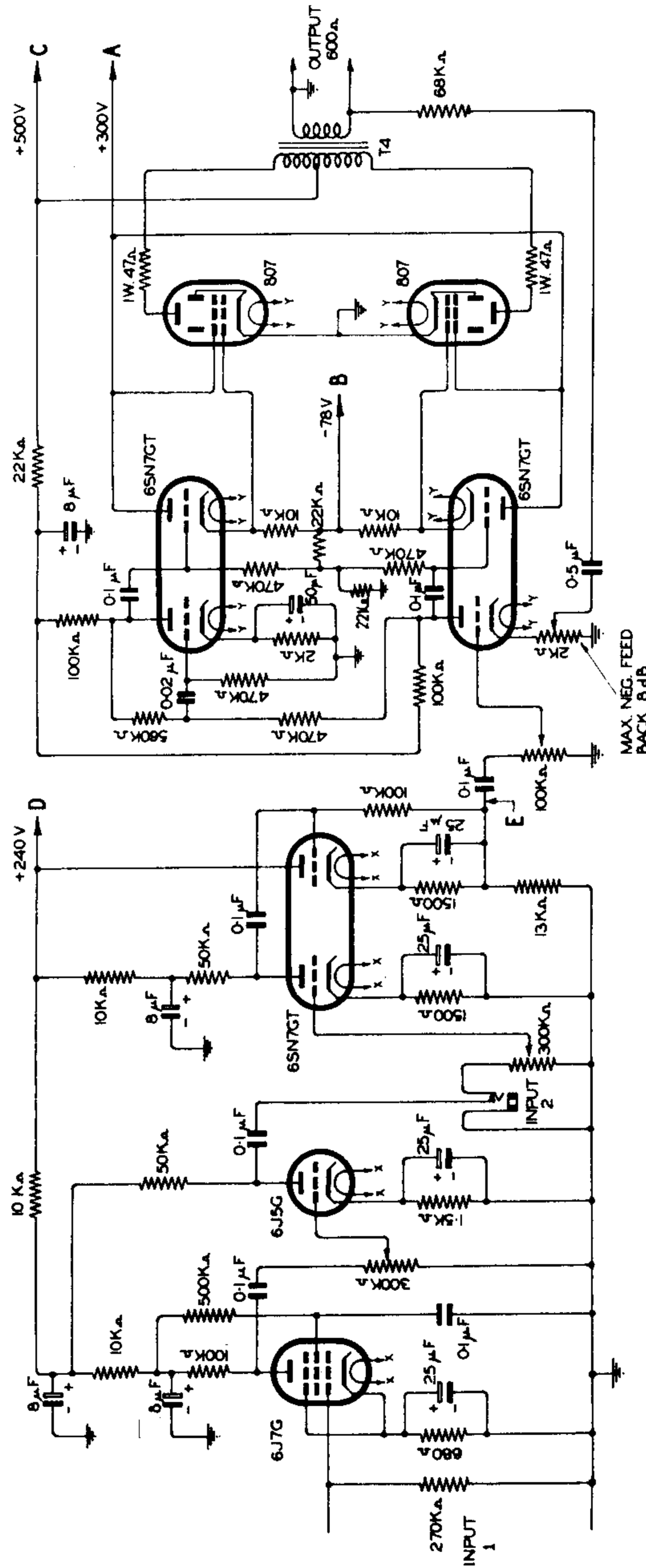

PHASE SPLITTER DRIVER OUTPUT

PRE - AMPLIFIER

MAX. NEG. FEED BACK 8 dB





REF. No. 401-12

POWER SUPPLY FOR 75 WATT CLASS 'AB₂' AMPLIFIER

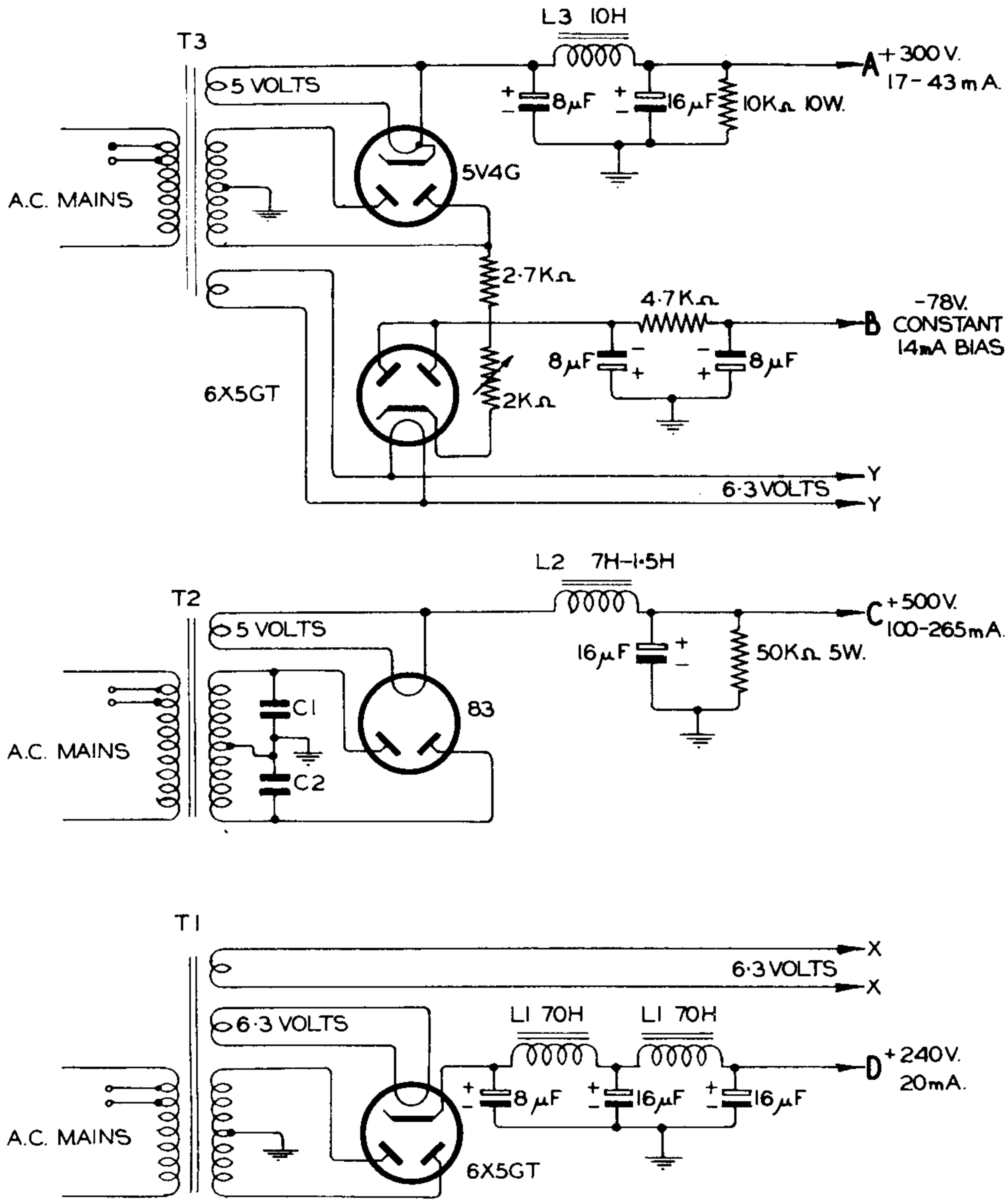

C1 & C2 = 0.01 μF 2,200V. D.C. WORKING.





TRANSFORMER AND CHOKE DATA FOR 75 WATT AMPLIFIER

401.21/1

Mains Transformer T1 (Ref. 401.20)

Secondary:

260-0-260 volts 20 mA; 6.3 volts 1.5 amperes and 6.3 volts 0.3 ampere.

Laminations:

Sankey No. 4A Stalloy 1 in. stack.

Primary winding for 200, 220, 240 volts:

1640 + 180 + 180 turns of 30 S.W.G. S.S.E. wire, DC resistance 58 ohms.

Secondary winding:

(a) 2300 + 2300 turns of 36 S.W.G. S.S.E. wire, DC resistance 470 ohms total.

(b) 60 turns 22 S.W.G. enamel.

(c) 56 turns 22 S.W.G. enamel.

Magnetising current: 36 mA.

Chokes L1 (Ref. 401.20)

70 Hy at 20 mA DC. 2200 Ω DC resistance.
HT voltage at output of filter 240 volts DC.

Mains Transformer T2 (Ref. 401.12)

Secondary:

600-0-600 volts 260 mA and 5 volts 3 amperes.

Laminations:

Sankey No. 28A Stalloy 1 $\frac{3}{4}$ in. stack.

Primary winding for mains voltages 200, 220, 240 volts:

800 + 80 + 80 turns of 22 S.W.G. enamel (8 ohms resistance).

Secondary winding:

(a) 5000 turns centre tapped, 28 S.W.G. S.S.E. wire (205 ohms resistance).

(b) 21 turns 18 S.W.G. enamel.

Magnetising current: approx. 100 mA.

Mains Transformer T3 (Ref. 401.12)

Secondary:

270-0-270 volts 90 mA, 5 volts 2 amperes and 6.3 volts 3.6 amperes.

Laminations:

Sankey No. 4A Stalloy 1 $\frac{1}{2}$ in. stack.

Primary winding for mains voltages 200, 220, 240 volts:

1200 + 120 + 120 turns of 28 S.W.G. S.S.E. wire (37 ohms resistance).

Secondary winding:

(a) 3300 turns centre tapped, 34 S.W.G. S.S.E. wire (320 ohms).

(b) 36 turns 20 S.W.G. enamel.

(c) 43 turns 18 S.W.G. enamel.

Magnetising current: approx. 50 mA.

Swinging Choke L2 (500 volts supply) (Ref. 401.12)

Laminations:

Stalloy No. 4A Stalloy 1 $\frac{1}{2}$ in. stack.

Gap spacer .005 in.

2000 turns of 24 S.W.G. enamel wire (25 $\frac{1}{2}$ ohms resistance).

Inductance:

Approx. 7 Hy with 50 mA DC.

2 Hy with 250 mA DC.





TRANSFORMER AND CHOKE DATA FOR 75 WATT AMPLIFIER (*continued*)

Smoothing Choke L3 (300 volts supply)

Laminations:

Sankey No. 4A Stalloy $1\frac{1}{2}$ in. stack.

Gap spacer .015 in.

3400 turns of 26 S.W.G. enamel wire (95 ohms resistance).

Inductance:

Approx. 11 Hy with no DC.

8 Hy with 100 mA DC.

Output Transformer T4 (75 watts)

Laminations:

Sankey No. 28A Stalloy $1\frac{3}{4}$ in. stack.

Gap spacer .015 in.

Ratio 2.74 : 1 to match 4500 to 600 ohms.

(Max. out of balance current 20 mA).

(Peak AC 250 mA).

Primary winding:

Two sections of 1500 turns each, of 26 S.W.G. D.S.C. wire
(73 ohms).

Secondary winding:

Three sections of 370 turns each, of 22 S.W.G. enamel wire
(11 ohms) sandwiched with primary sections.

Leakage inductance: less than 0.3%.

Primary inductance:

Approx. 12 Hy with no DC.

12 Hy with 50 mA DC (through both primary sections).

AN I.T.E.T.
ASSOCIATE



PERFORMANCE DATA FOR 75 WATT AMPLIFIER

401.22/1

PRE-AMPLIFIER

General:

Output load used for measurements is 10,000 ohms at 'E'
(Ref. 401.20).

Output voltages measured at 'E'.

Measurements made at 1000 c/s.

Gain:

Input to No. 1 for 10 volts R.M.S. output = 0.5 millivolt.

" " " 2 " " " " " " = 0.65 volt.

Harmonic Distortion at 1000 c/s.

Harmonic	% at 10 volts Output	% at 20 volts Output
2nd	0.11	0.9
3rd	0.10	0.75
4th	—	0.27
5th	—	0.09

1000 c/s injected at input 1 with distortion less than 0.01% of any harmonic.

Hum Levels:

Hum voltage on HT line: 0.05 volt R.M.S.

Hum output at 'E' with first gain control of pre-amplifier at minimum and second gain control at maximum: 0.12 volt of 50 c/s; 0.06 volt of 100 c/s.

OUTPUT UNIT

Frequency Response:

Gain control at maximum. Figures taken at output level of 30 watts. Input applied at 'E' (Ref. 401.20) constant.

Frequency C.P.S.	No Shunting on Output Transformer	5K Ω and .0015 μ F Shunting (plate-plate)	5K Ω and .0015 μ F Shunting (plate-plate)*
50	-1.6 dB	-1.6 dB	-0.5 dB
100	-0.7 dB	-0.7 dB	0 dB
400	0 dB	0 dB	0 dB
1000	0 dB	0 dB	0 dB
3000	0 dB	0 dB	0 dB
10,000	-0.2 dB	-2.0 dB	-1.6 dB
13,000	0.9 dB	-1.6 dB	-0.5 dB
20,000	-2.4 dB	-5.3 dB	-1.4 dB

Input at 'E' at 1000 c/s for maximum output = 4 volts R.M.S.

* Input at 'E' at 1000 c/s for maximum output = 10 volts R.M.S.

Hum output across 600 ohm load	50c/s	100c/s
	0.25 volt	0.13 volt
* " " " " " "	0.13 volt	0.05 volt

* These figures apply for 8 dB negative feedback.





PERFORMANCE DATA
FOR 75 WATT AMPLIFIER (continued)

Operating Voltages and Currents*:

	807 Plates	807 Screen Grids	Each 807 Cathode	300 volts HT Line	78 volts Bias Line	Bias
No drive	volts 508	volts 300	mA 47	mA 17	mA 14	volts —78
Max. output	475	280	125	43	14	—78

Harmonic Distortion at 1000c/s (5K Ω and .0015 μ F on output transformer):

Harmonic	25 watts Output†		50 watts Output †		75 watts Output†		70 watts Output*	
	Zero	Max.	Zero	Max.	Zero	Max.	Zero	Max.
2	1.0	.34	1.1	.5	.9	.45	1.0	.92
3	.9	.25	1.3	.62	7.5	5.0	6.0	2.9
4	.13	.05	.25	.12	.7	.23	.9	.93
5	.3	.14	.45	.28	2.7	4.0	3.2	6.0
7	.16	.07	.66	.22	.15	.8	.13	2.0
9	.05	.02	.32	.15	.5	.2	.16	.65

† The 25 watt, 50 watt, and 75 watt figures were taken with perfect HT and screen supply regulation.

* The 70 watt figures were obtained at maximum output with the regulation given above.

Distortion figures at 100c/s were slightly higher than at 1000c/s averaging 1.1—1.2 times more.

Maximum output at 100c/s was 68 watts.

AN ITC
ASSOCIATE

MODIFIED ZERO BIAS CLASS 'B' AMPLIFIER

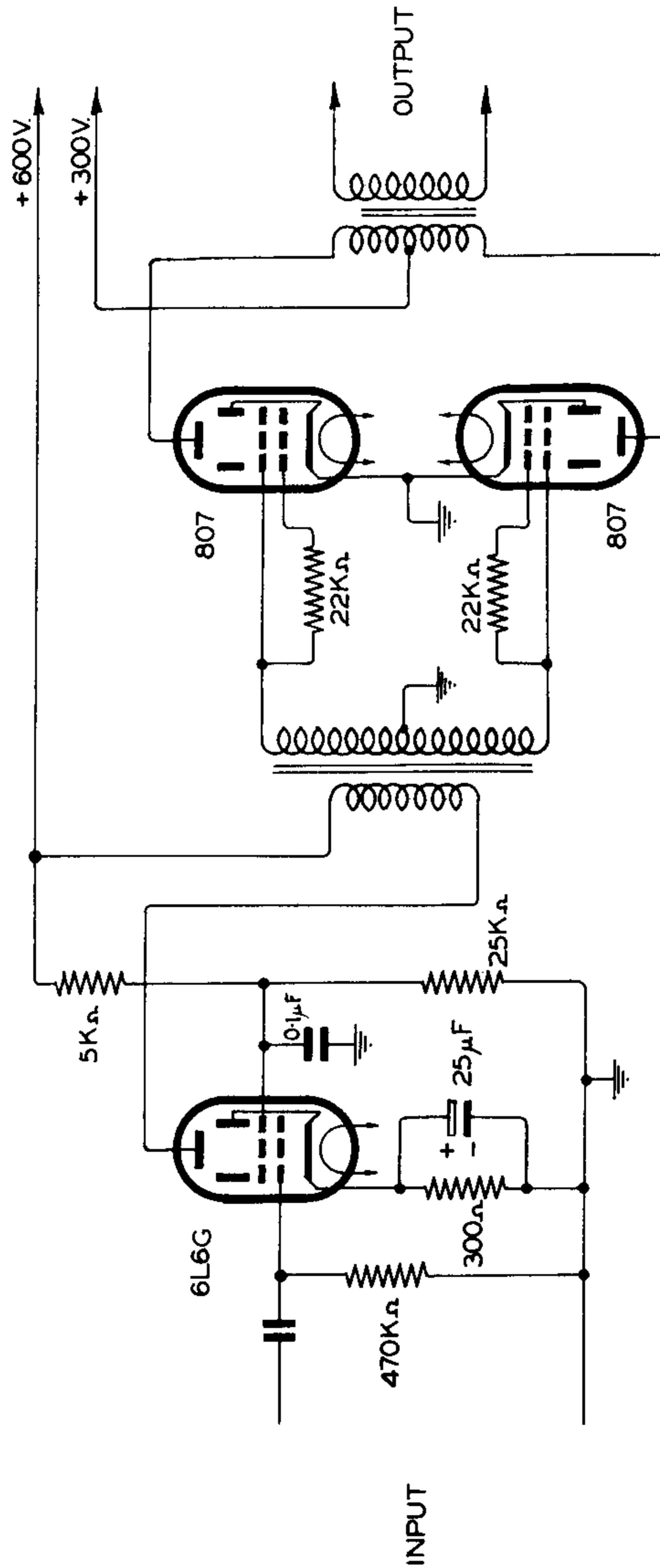

DRIVER STAGE

PLATE LOAD IMPEDANCE = 4200 OHMS

OUTPUT STAGE

GRID-TO-GRID INPUT VOLTAGE = 554 VOLTS
 GRID-TO-GRID INPUT POWER = 5.3 WATTS
 GRID-TO-GRID INPUT IMPEDANCE = 7,100 OHMS
 PLATE-TO-PLATE LOAD IMPEDANCE = 6,600 OHMS